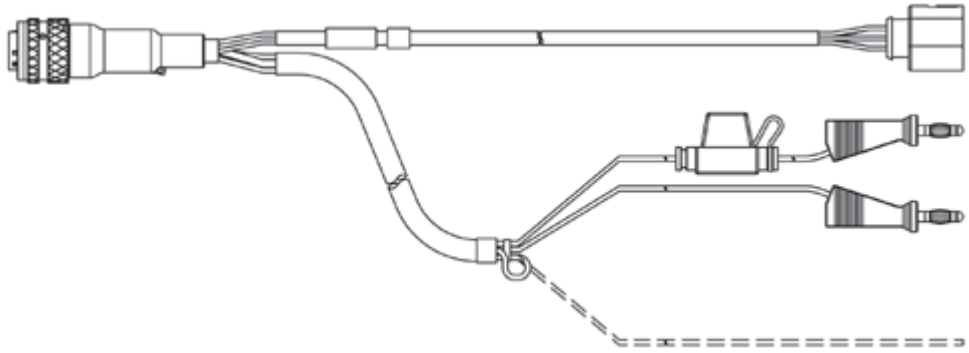

订货信息

产品名称	长度	简称	订购号
ES630 [1]			
λ模块 (1-CH)		ES630.1	F-00K-106-296
λ模块 (1-CH) , 包括LSU 4.9		ES630.1-4.9	F-00K-106-294
包括1x LSUS_49 和 1x CBAL452.1-3			
博世氧传感器LSU 4.9、SR4、RB150代 码1连接器、300欧姆、1m / 3.3 ft	1.00 m 3.28 ft	LSUS_49	0-258-017-025
λ传感器电缆 LSU 4.9, Souriau 8ST12- 35 - RB150 (Code 1) - Banana (22mc- 6fc+2mc+2mc), 3 m	3.00 m 9.84 ft	CBAL452.1-3	F-00K-106-127
			
包阔LSU ADV-G的λ模块 (1-CH)		ES630.1-ADV-G	F-00K-106-983
包括 1个 LSU_ADV_G 和 1个 CBAL463-3			
用于汽油机的λ传感器LSU ADV-G, 保 护管TP3, 梯形插头, Code A7, 300 Ohms, 1m / 3.3 ft	1.00 m 3.28 ft	LSU_ADV_G	F-00K-106-409

λ传感器电缆LSU ADV, Souriau 8ST12-35 - 梯形插头, Code A7 - Banana - BNC (22mc-7fc+2mc+2mc), 3m / 9.8 ft

3.00 m
9.84 ft

CBAL463.1-3

F-00K-106-310

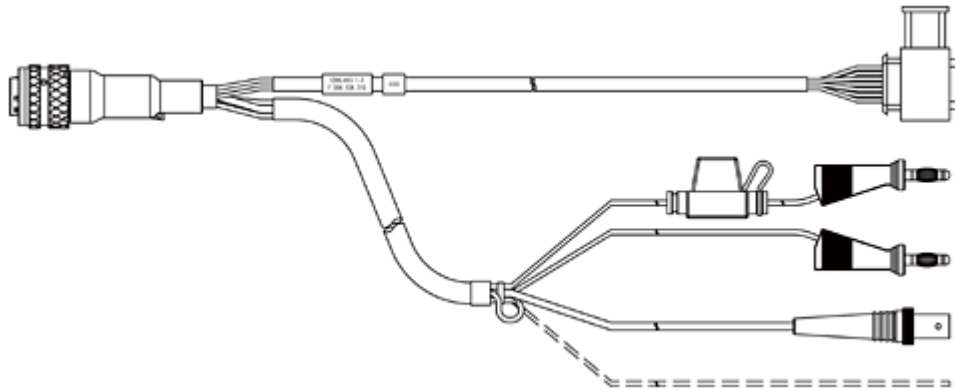

ES631 [1]

λ模块 (2-CH)

ES631.1

F-00K-106-297

λ模块 (2-CH) , 包括LSU 4.9

ES631.1-4.9

F-00K-106-295

包括 2x LSUS_49 和 2x CBAL452.1-3

博世氧传感器LSU 4.9、SR4、RB150代码1连接器、300欧姆、1m / 3.3 ft

1.00 m
3.28 ft

LSUS_49

0-258-017-025

λ传感器电缆 LSU 4.9, Souriau 8ST12-35 - RB150 (Code 1) - Banana (22mc-6fc+2mc+2mc), 3 m

3.00 m
9.84 ft

CBAL452.1-3

F-00K-106-127

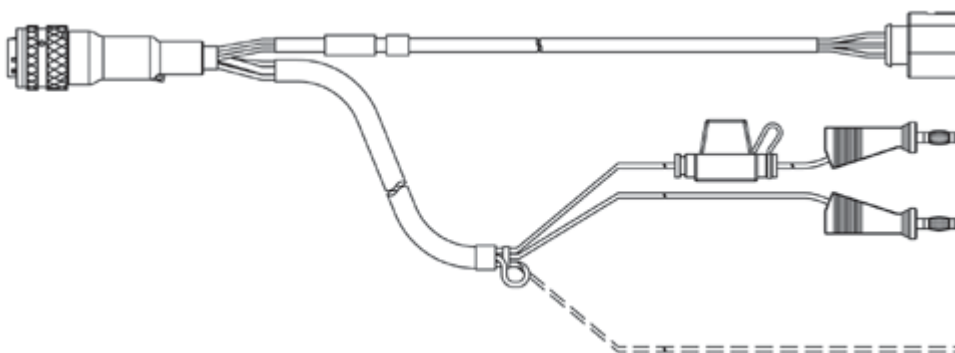

包含LSU ADV-G的λ模块 (2-CH)

ES631.1-ADV-G

F-00K-106-984

包括 2个 LSU_ADV_G 和 2个 CBAL463-3

用于汽油机的λ传感器LSU ADV-G, 保护管TP3, 梯形插头, Code A7, 300 Ohms, 1m / 3.3 ft

1.00 m
3.28 ft

LSU_ADV_G

F-00K-106-409

λ传感器电缆LSU ADV, Souriau 8ST12-35 - 梯形插头, Code A7 - Banana - BNC (22mc-7fc+2mc+2mc), 3m / 9.8 ft

3.00 m
9.84 ft

CBAL463.1-3

F-00K-106-310

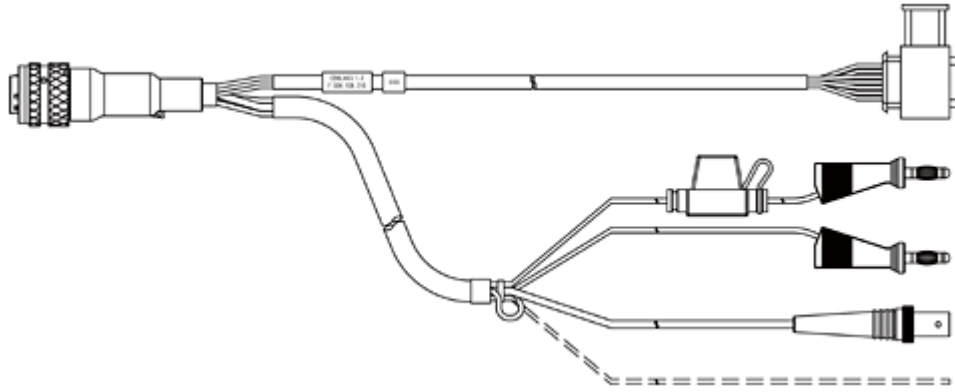

ES635 [1]

λ模块 (1-CH)

ES635.1

F-00K-106-675

λ模块 (1-CH) , 包括LSU 4.9

ES635.1-4.9

F-00K-106-673

包括 1x LSUS_49 和 1x CBAL452.1-3 和 1x PS63

博世氧传感器LSU 4.9、SR4、RB150代码1连接器、300欧姆、1m / 3.3 ft

1.00 m
3.28 ft

LSUS_49

0-258-017-025

λ传感器电缆 LSU 4.9, Souriau 8ST12-35 - RB150 (Code 1) - Banana (22mc-6fc+2mc+2mc), 3m

3.00 m
9.84 ft

CBAL452.1-3

F-00K-106-127

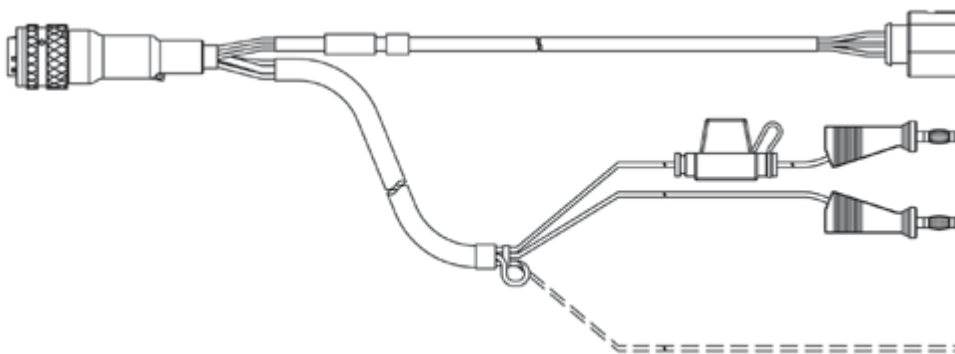

压力传感器

PS63

F-00K-106-679

λ模块 (1-CH) , 包括LSU ADV-G	ES635.1-ADV-G	F-00K-106-677
--------------------------	---------------	---------------

包括 1x LSU_ADV_G 和 1x CBAL463-3 和 1x PS63

用于汽油机的λ传感器LSU ADV-G, 保护管TP3, 梯形插头, Code A7, 300 Ohms, 1m / 3.3 ft	1.00 m 3.28 ft	LSU_ADV_G	F-00K-106-409
---	-------------------	-----------	---------------

λ传感器电缆LSU ADV, Souriau 8ST12-35 - 梯形插头, Code A7 - Banana - BNC (22mc-7fc+2mc+2mc), 3m / 9.8 ft	3.00 m 9.84 ft	CBAL463.1-3	F-00K-106-310
--	-------------------	-------------	---------------

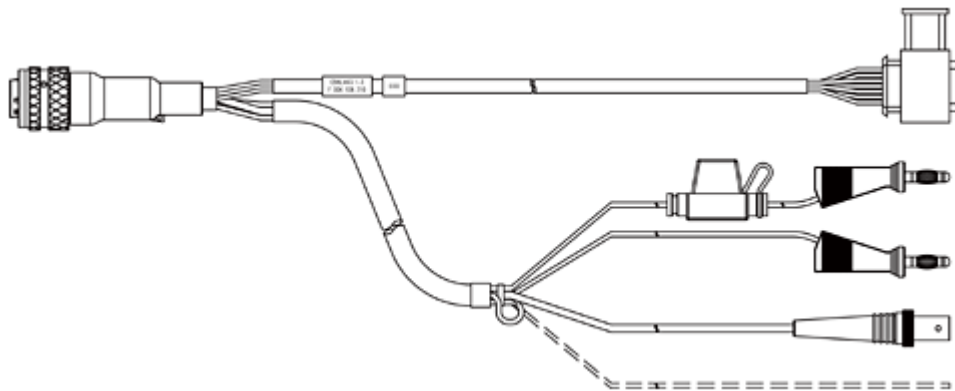

压力传感器	PS63	F-00K-106-679
-------	------	---------------

ES636 [1]

λ模块 (2-CH)	ES636.1	F-00K-106-676
------------	---------	---------------

λ模块 (2-CH) , 包括LSU 4.9	ES636.1-4.9	F-00K-106-674
------------------------	-------------	---------------

包括 2x LSUS_49 和 2x CBAL452.1-3 和 2x PS63

博世氧传感器LSU 4.9、SR4、RB150代码1连接器、300欧姆、1m / 3.3 ft	1.00 m 3.28 ft	LSUS_49	0-258-017-025
---	-------------------	---------	---------------

λ传感器电缆 LSU 4.9, Souriau 8ST12-35 - RB150 (Code 1) - Banana (22mc-6fc+2mc+2mc), 3 m	3.00 m 9.84 ft	CBAL452.1-3	F-00K-106-127
--	-------------------	-------------	---------------

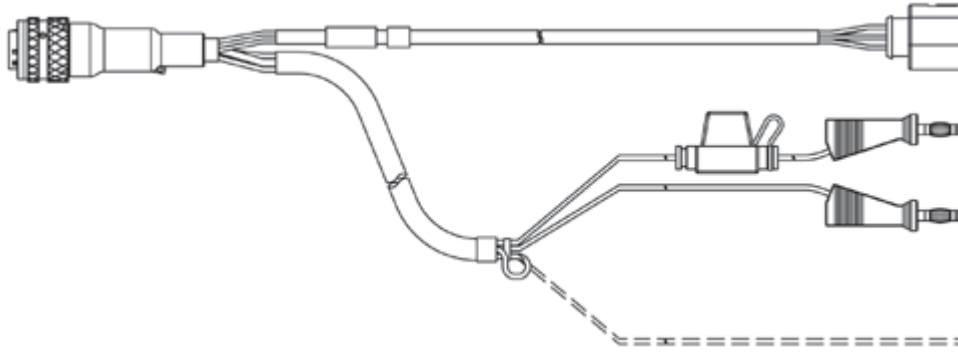

压力传感器	PS63	F-00K-106-679
-------	------	---------------

λ模块 (2-CH) , 包括LSU ADV-G	ES636.1-ADV-G	F-00K-106-678
--------------------------	---------------	---------------

包括 2x LSU_ADV_G 和 2x CBAL463-3 和 2x PS63

用于汽油机的λ传感器LSU ADV-G, 保护管TP3, 梯形插头, Code A7, 300 Ohms, 1m / 3.3 ft	1.00 m 3.28 ft	LSU_ADV_G	F-00K-106-409
---	-------------------	-----------	---------------

λ传感器电缆LSU ADV, Souriau 8ST12-35 - 梯形插头, Code A7 - Banana - BNC (22mc-7fc+2mc+2mc), 3m / 9.8 ft	3.00 m 9.84 ft	CBAL463.1-3	F-00K-106-310
--	-------------------	-------------	---------------

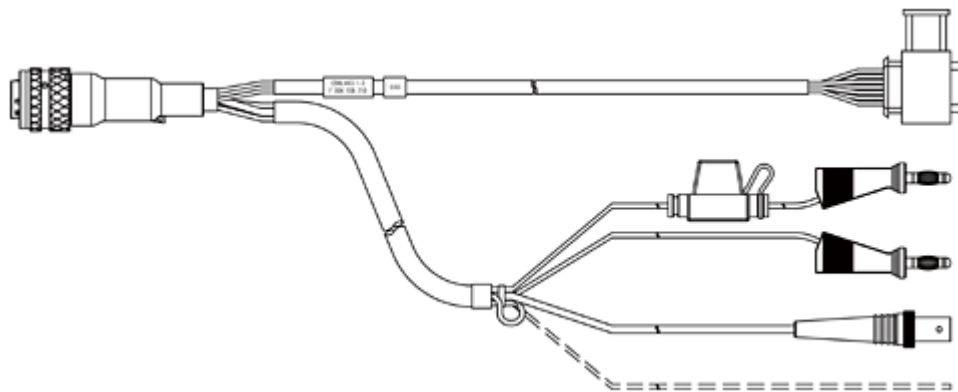

压力传感器	PS63	F-00K-106-679
-------	------	---------------

ES630 / ES631 / ES635 / ES636 可选配件

高性价比open Lemo 1B插口防尘保护帽,	CAP_LEMO_1B_LC	F-00K-105-683
--------------------------	----------------	---------------



盖子保护展开的Souriau插座免受污垢，
具有成本效益

CAP_SOURIAU_8STA F-00K-105-303

独立配置[2,4]

供电电缆, Lemo 1B FGL -Banana (8mc-2mc), 2m	2.00 m 6.56 ft	CBP630.1-2	F-00K-106-312
--	-------------------	------------	---------------

供电电缆, Lemo 1B FGL - Safety Banana (8mc-2mc), 2m	2.00 m 6.56 ft	CBP6305.1-2	F-00K-110-022
--	-------------------	-------------	---------------



主机连接及供电 [3,4,5,7]

以太网PC连接和供电电缆, Lemo 1B FGL - RJ45 - Banana (8fc-8mc+2mc), 3 m	3.00 m 9.84 ft	CBEP410.1-3	F-00K-104-927
--	-------------------	-------------	---------------

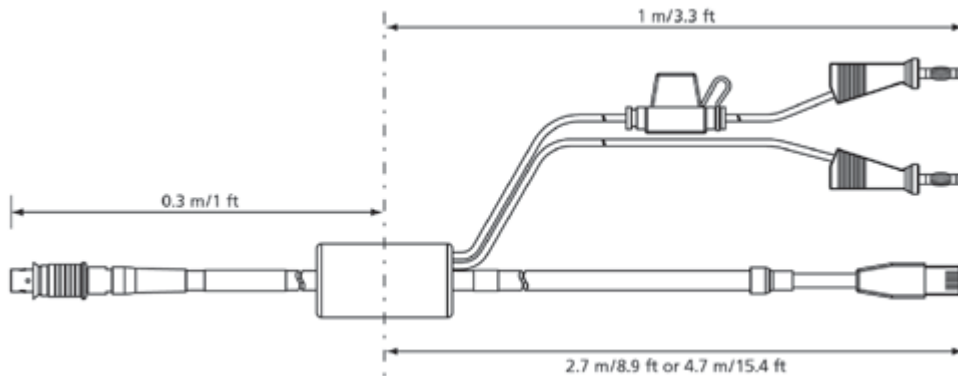

以太网PC连接和供电电缆, Lemo 1B FGL - RJ45 - Safety Banana (8fc- 8mc+2mc), 3 m	3.00 m 9.84 ft	CBEP4105.1-3	F-00K-110-026
--	-------------------	--------------	---------------

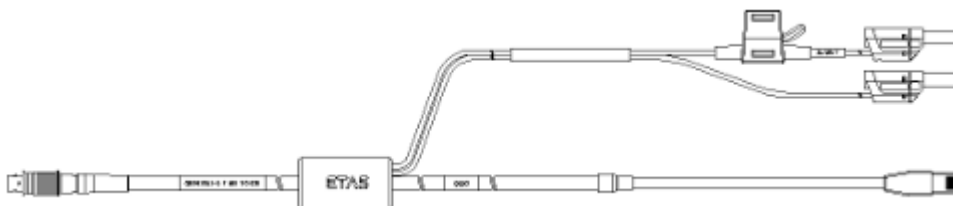

以太网PC连接和供电电缆, 供电线靠近 电脑, Lemo 1B FGL - RJ45 - Banana (8fc-8mc+2mc), 5 m	5.00 m 16.40 ft	CBEP415.1-5	F-00K-105-680
--	--------------------	-------------	---------------

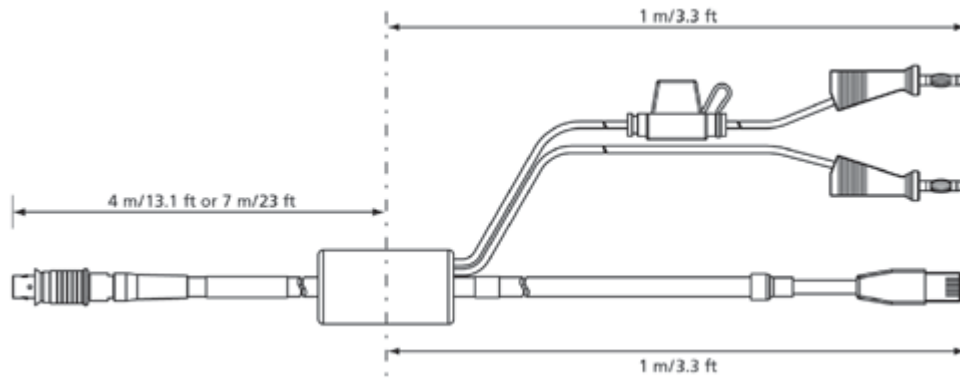

以太网PC连接和供电电缆，供电线靠近
 电脑，Lemo 1B FGL - RJ45 - Safety 5.00 m CBEP4155.1-5 F-00K-110-027
 Banana (8fc-8mc+2mc), 5 m 16.40 ft

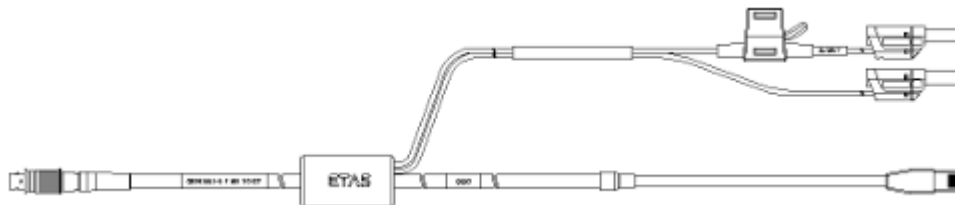

为以下产品提供电力和连接：ES592, ES593或ES595接口模块/ES600网络模块 [3,4,5,7]

以太网连接和电源线, Lemo 1B FGF - 3.00 m CBEP420.1-3 F-00K-105-292
 Lemo 1B FGL - Banana (8mc-8fc+2mc), 9.84 ft
 3 m

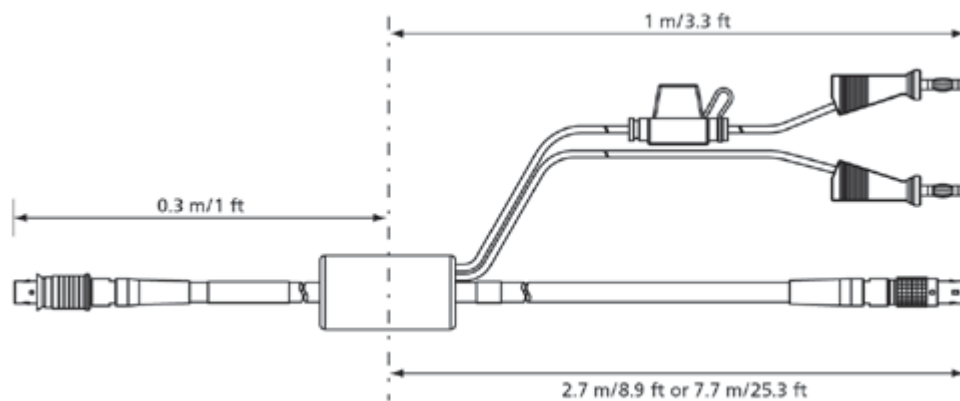

以太网连接和电源线, Lemo 1B FGF - 3.00 m CBEP4205.1-3 F-00K-110-041
 Lemo 1B FGL - Safety Banana (8mc- 9.84 ft
 8fc+2mc), 3 m

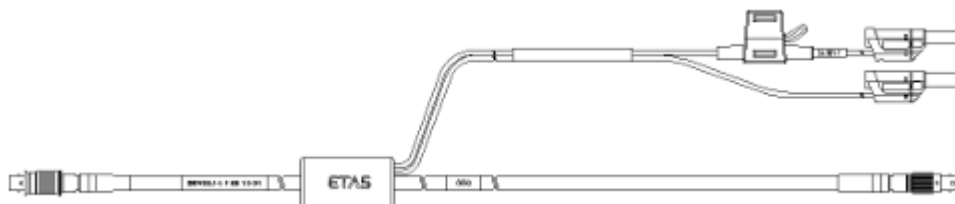

以太网连接和电源线, Lemo 1B FGF - Lemo 1B FGL - Banana (8mc-8fc+2mc), 3 m	3.00 m 9.84 ft	CBEP425.1-3	F-00K-105-972
--	-------------------	-------------	---------------

以太网连接和电源线, Lemo 1B FGF - Lemo 1B FGL - Safety Banana (8mc- 8fc+2mc), 3 m	3.00 m 9.84 ft	CBEP4255.1-3	F-00K-110-029
--	-------------------	--------------	---------------

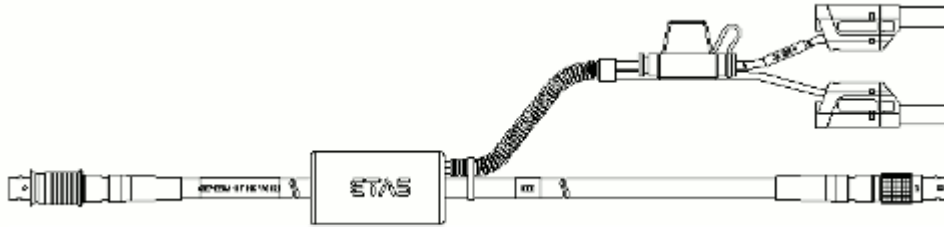

连接ES400、ES63x 测量模块和电源[3,4,6,8]

以太网链连接和供电电缆, Lemo 1B FGL - Lemo 1B FGA - Banana (8fc- 8mc+2mc), 0m5	0.50 m 1.64 ft	CBEP430.1-0m5	F-00K-104-928
---	-------------------	---------------	---------------

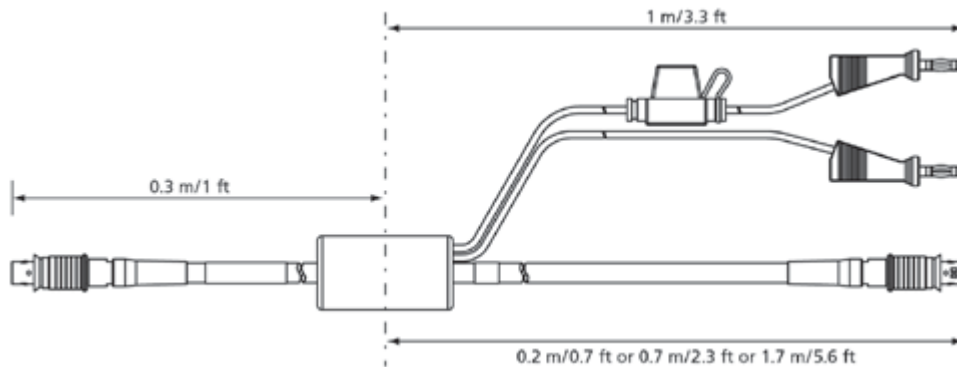

以太网链连接和供电电缆, Lemo 1B FGL - Lemo 1B FGA - Safety Banana (8fc-8mc+2mc), 0m5	0.50 m 1.64 ft	CBEP4305.1-0m5	F-00K-110-030
---	-------------------	----------------	---------------

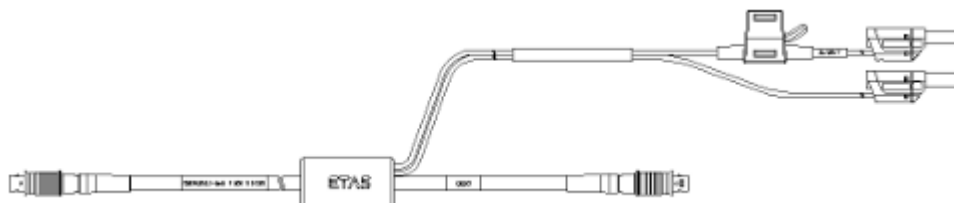

连接 ES600 网络模块[3,4,5]

以太网PC连接电缆, Lemo 1B FGF - Lemo 1B FGL (8mc-8fc), 3 m	3.00 m 9.84 ft	CBE400.2-3	F-00K-104-920
--	-------------------	------------	---------------

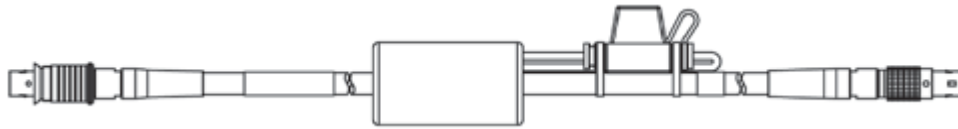

以太网PC连接电缆, 高度柔韧, Lemo 0.50 m
1B FGF - Lemo 1B FGL (8mc-8fc), 0m5 1.64 ft CBE401.1-0m5 F-00K-106-128

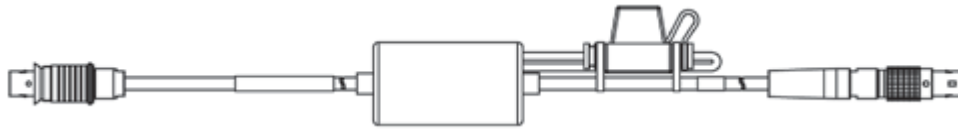

连接 ES400 和ES63x 测量模块 [3,6]

以太网链连接电缆, Lemo 1B FGA - 0.45 m
Lemo 1B FGL (8mc-8fc), 0m45 1.48 ft CBE430.1-0m45 F-00K-104-923

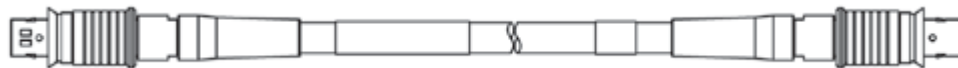

以太网链连接电缆, 高度柔韧, Lemo 0.14 m
1B FGA - Lemo 1B FGL (8mc-8fc), 0m14 0.46 ft CBE431.1-0m14 F-00K-105-676



以太网链连接电缆, 高度柔韧, Lemo 0.30 m
1B FGA - Lemo 1B FGL (8mc-8fc), 0m3 0.98 ft CBE431.1-0m3 F-00K-105-685



以太网延长电缆, Lemo 1B PHL - Lemo 3.00 m
1B FGL (8mc-8fc), 3 m 9.84 ft CBEX400.1-3 F-00K-105-294



SMB 连接

SMB连接 Y型电缆, DSUB - DSUB - 0.30 m
DSUB (15fc-9mc-9mc), 0m3 0.98 ft CBAS100.1-0m3 F-00K-106-313

LSU 4.2 氧传感器和LSU 4.2 /LSU 4.7 传感器电缆[9]

Bosch λ 传感器 LSU 4.2, 用于带通用连接器的λ测量仪, 1m	1.00 m 3.28 ft	LSUS_42	0-258-007-151
--	-------------------	---------	---------------

λ 传感器电缆 LSU 4.2 和 LSU 4.7, Souriau 8ST12-35 - RB130fl - Banana - BNC (22mc-6fc+2mc+2mc), 3m	3.00 m 9.84 ft	CBAL410.1-3	F-00K-106-302
---	-------------------	-------------	---------------

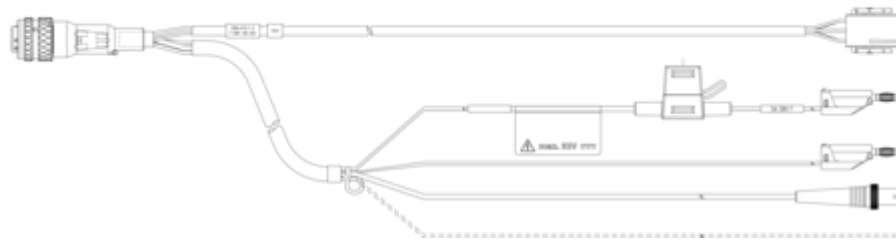

λ 传感器电缆 LSU 4.2 和 LSU 4.7, Souriau 8ST12-35 - RB130fl - Safety Banana - BNC (22mc-6fc+2mc+2mc), 3m	3.00 m 9.84 ft	CBAL4105.1-3	F-00K-110-033
--	-------------------	--------------	---------------

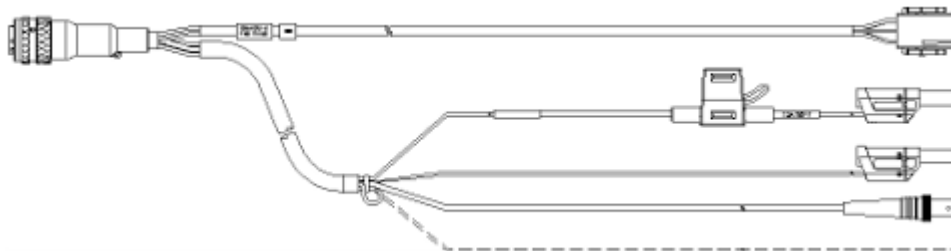

LSU 4.9 λ氧传感器和传感器电缆 [9]

博世氧传感器 LSU 4.9、SR4、RB150 代码1连接器、300欧姆、1m / 3.3 ft	1.00 m 3.28 ft	LSUS_49	0-258-017-025
---	-------------------	---------	---------------

λ 传感器电缆 LSU 4.9, Souriau 8ST12-35 - RB150 (Code 1) - Banana - BNC (22mc-6fc+2mc+2mc), 3 m	3.00 m 9.84 ft	CBAL451.1-3	F-00K-105-926
---	-------------------	-------------	---------------

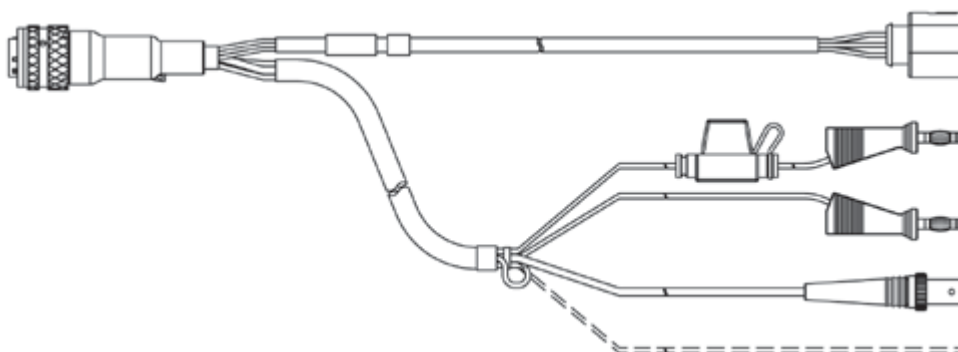

λ传感器电缆 LSU 4.9, Souriau 8ST12-35 - RB150 (Code 1) - Safety Banana - BNC (22mc-6fc+2mc+2mc), 3 m

3.00 m
9.84 ft

CBAL4515.1-3

F-00K-110-038

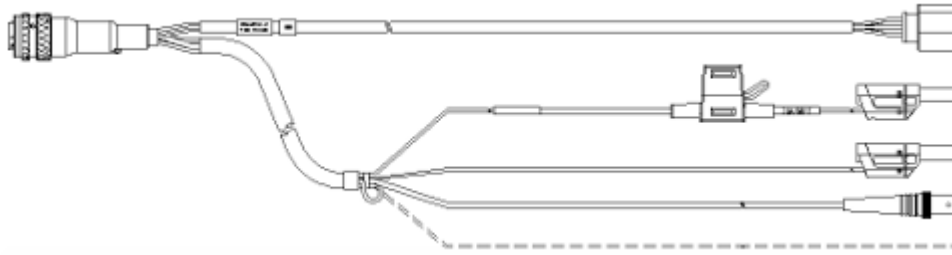

λ传感器电缆 LSU 4.9, Souriau 8ST12-35 - RB150 (Code 1) - Banana (22mc-6fc+2mc+2mc), 3 m

3.00 m
9.84 ft

CBAL4521.1-3

F-00K-106-127

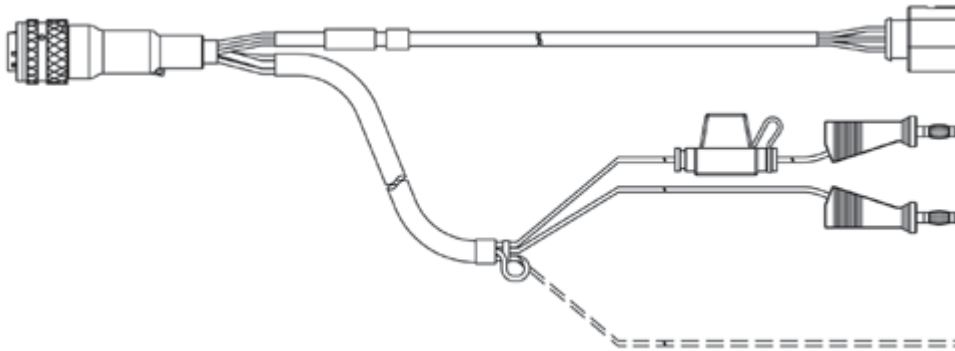

λ传感器电缆 LSU 4.9, Souriau 8ST12-35 - RB150 (Code 1) - Safety Banana (22mc-6fc+2mc+2mc), 3 m

3.00 m
9.84 ft

CBAL4525.1-3

F-00K-110-039

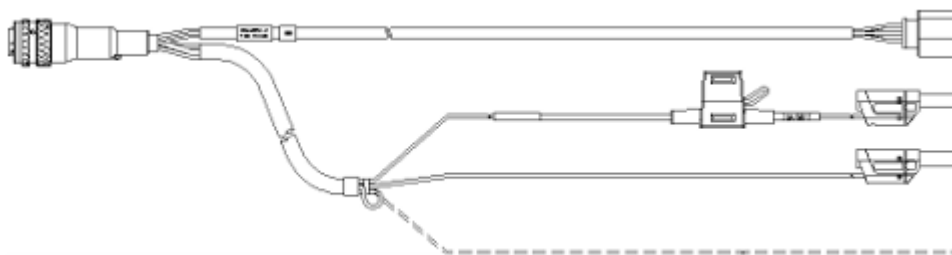

λ传感器电缆 LSU 4.9, Souriau 8ST12-35 - RB150 (Code A) - Banana - BNC (22mc-6fc+2mc+2mc), 5 m / 16.4 ft

5.00 m
16.40 ft

AS_CBAL455.1-5

F-00K-106-308

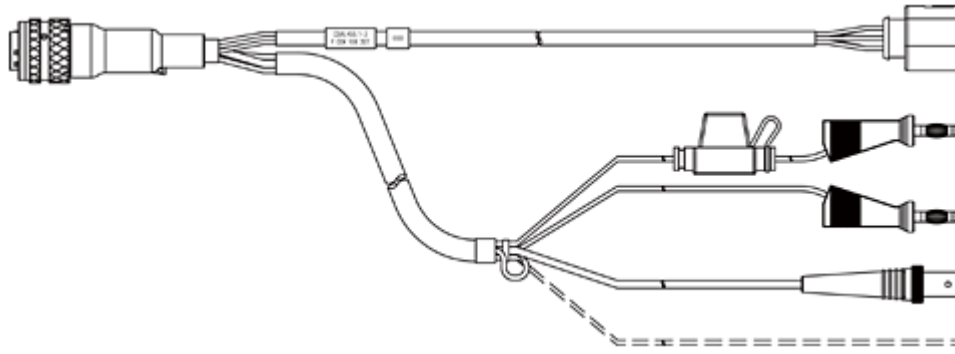

LSU ADV λ氧传感器和传感器电缆 [10]

用于汽油机的λ传感器LSU ADV-G, 保护管TP3, 梯形插头, Code A7, 300 Ohms, 1m / 3.3 ft

1.00 m
3.28 ft

LSU_ADV_G

F-00K-106-409

λ传感器电缆LSU ADV, Souriau 8ST12-35 - 梯形插头, Code A7 - Banana - BNC (22mc-7fc+2mc+2mc), 3m / 9.8 ft

3.00 m
9.84 ft

CBAL463.1-3

F-00K-106-310

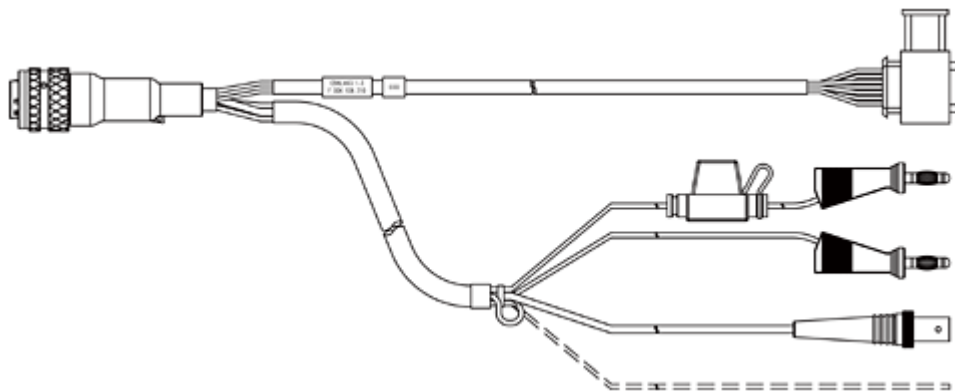

λ传感器电缆LSU ADV, Souriau 8ST12-35 - 梯形插头, Code A7 - Safety Banana - BNC (22mc-7fc+2mc+2mc), 3m / 9.8 ft

3.00 m
9.84 ft

CBAL4635.1-3

F-00K-110-035

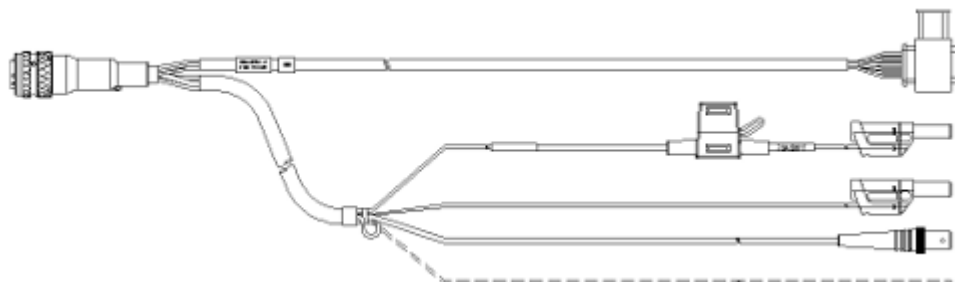

NTK ZFAS®-U2 λ氧传感器线缆 [11]

λ传感器线缆ZFAS®-U2,Souriau 8ST12-
35 - RB150 (代号1)- Banana (22mc-
6fc+2mc), 3 m / 9.8 ft

3.00 m
9.84 ft

CBAL4721.1-3

F-00K-107-313

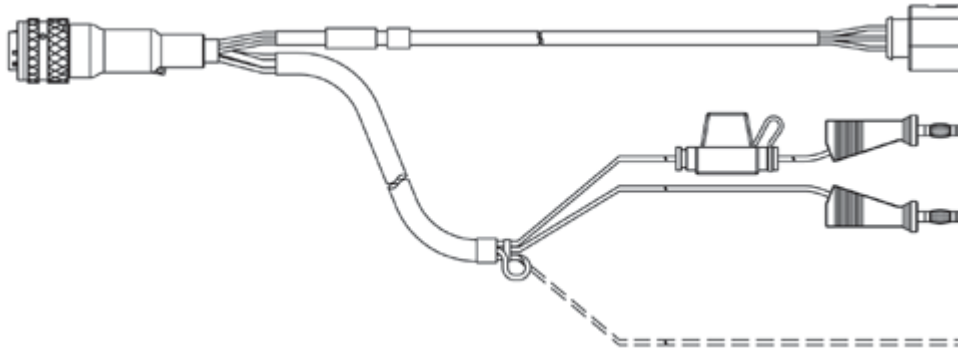

λ传感器线缆ZFAS®-U2,Souriau 8ST12-
35 - RB150 (代号1)- Safety Banana
(22mc-6fc+2mc), 3 m / 9.8 ft

3.00 m
9.84 ft

CBAL4725.1-3

F-00K-110-040

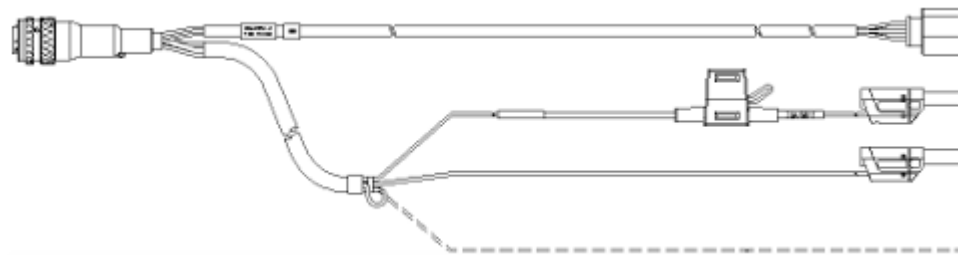

外部压力传感器和延长电缆 (ES635/ES636可选配件)

压力传感器	PS63	F-00K-106-679
压力传感器 PS63的延长电缆	CBAX100.1-3	F-00K-106-680

注释

- [1] 套件中不包含电缆和以太网线
- [2] 温度范围-40°C (-40°F) 至 +70°C (158°F)
- [3] 温度范围-40°C (-40°F) 至 +125°C (257°F)
- [4] 包括逆极性、抛负载保护和标准保险丝
- [5] IP67额定Lemo连接器连至测量模块链
- [6] 两侧均有IP67额定Lemo连接器
- [7] 不兼容ES600/ES610/ES611/ES620/ES650 (CBEP120 电源线与 ES6xx搭配使用)
- [8] 不兼容ES59x, ES6xx, ES11xx (CBE130 或 CBE140连接线可用于以上设备).

[9] 标示传感器类型的TEDS码在传感器线缆上

[10] 标示传感器类型的TEDS码在λ氧传感器上

[11] NTK ZFAS®-U2λ氧传感器不是由ETAS提供

我们可根据您的规格定制电缆。如您需要更多关于定制电缆的信息，请联系您所在地区的ETAS销售代表。

