



# INCA V7.3 – What's New

Changes / Extensions done in this Version

# INCA V7.3 – What's New

## Overview

### 1. Product information (Use cases, Sample applications, Customer value)

- Performance

- **Functionality**

- Standards

- Usability

- HW support

- Add-ons

### 2. INCA Product Family

### 3. Phase out information

### 4. General Notes



# INCA V7.3 – What's New

## Functionality



### INCA as native 64Bit Windows Application

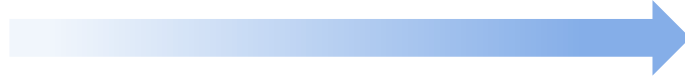
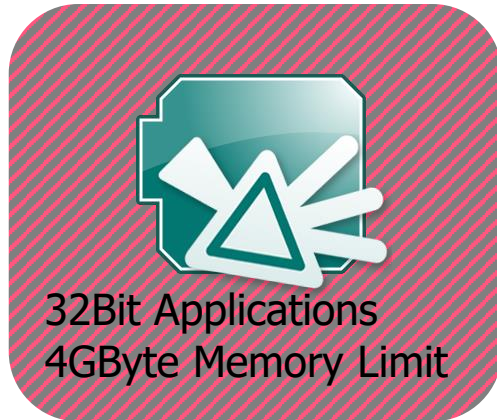

64Bit Applications  
Full Memory access

- There is no more restriction for usage of PC memory. INCA can utilize all the memory provided by an 64Bit PC / Windows OS
- Caching of huge data is possible. No reload necessary
- Big measure data buffers



### Recorder – Add Calibration Info to support Big Data

Add meta data to the recorded data on which base the measurement was done

- ECU software description (A2L file)
- Data sets loaded to the ECU
- Checksum to quickly identify differences
- File / Node ID to get a reference to the database with calibration data

```
<common_properties>
  <tree name="ASAM Target Description">
    <tree name="targets">
      <tree name="XCP:1">        <!-- unique target name -->
        <e name="name">Engine</e>
        <e name="type">Software</e>
        <tree name="description">
          <e name="description file">engine.a2l</e>
          <e name="checksum ecu side">0x1EF3</e> <!-- code part -->
          <e name="checksum tool side">0x1EF4</e> <!-- code part -->
          <e name="file id">897E2A</e>
          <e name="node id">93A64B</e>
        </tree>
      <tree name="dataset rp">
        <e name="description file">engine.hex</e>
        <e name="checksum ecu side">0x42F1</e> <!-- data part -->
        <e name="checksum tool side">0x56A3</e> <!-- data part -->
        <e name="file id">8734BC</e>
        <e name="node id">93A64B</e>
      </tree>
      <tree name="dataset wp">
        <e name="description file">engine_1.hex</e>
        <e name="checksum ecu side">0x34C1</e> <!-- data part -->
        <e name="checksum tool side">0x34C1</e> <!-- data part -->
        <e name="file id">66D723</e>
        <e name="node id">93A64B</e>
      </tree>
    </tree>
  </tree>
</common_properties>
```

# INCA V7.3 – What's New

## Functionality



### Recorder – Add Calibration Info to support Big Data

Add description files to the recorded data on which base the measurement was done

- ECU software description (A2L File)
- Data sets loaded to the ECU (Hex File)

With the links in the Meta Data the description files are linked to the related measurements.

INCA adds the description files optionally.

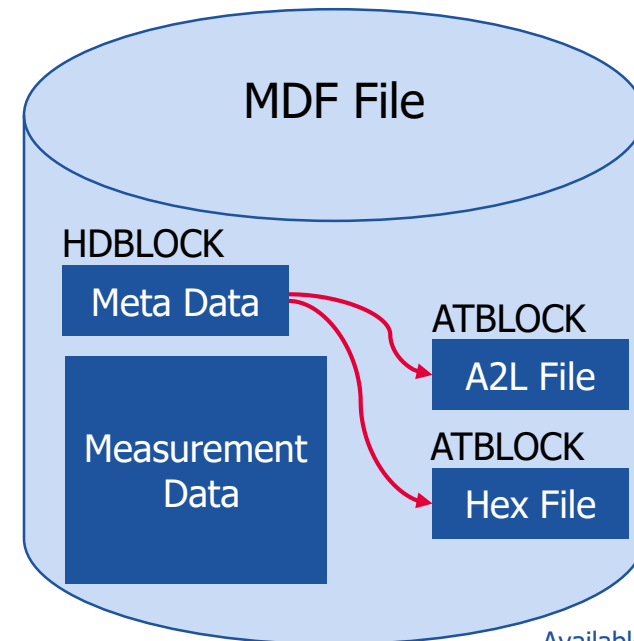
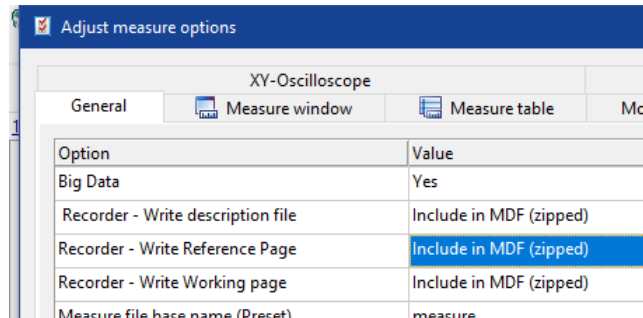

Available with INCA V7.3 SP1

# INCA V7.3 – What's New

## Functionality



### Recorder – Add Calibration Info to support Big Data

Add description files to the recorded data on which base the measurement was done

- ECU software description (A2L File)
- Data sets loaded to the ECU (Hex File)

Add calibration changes as events

With the links in the Meta Data the description files are linked to the related measurements.

INCA adds the description files optionally.

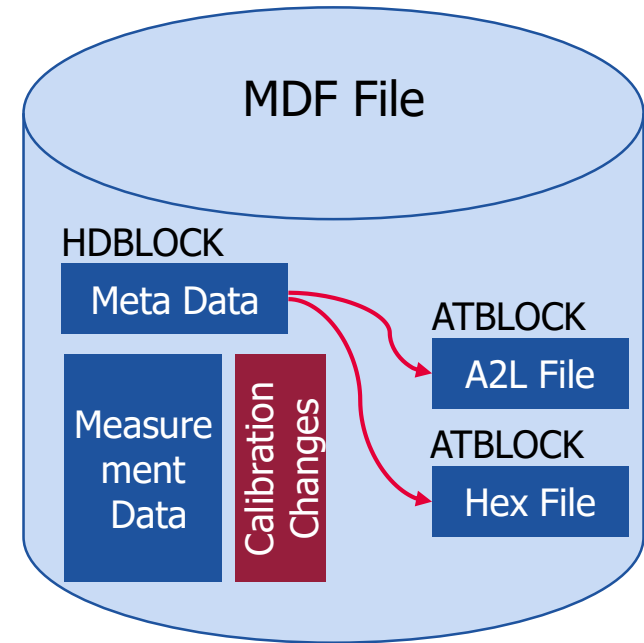
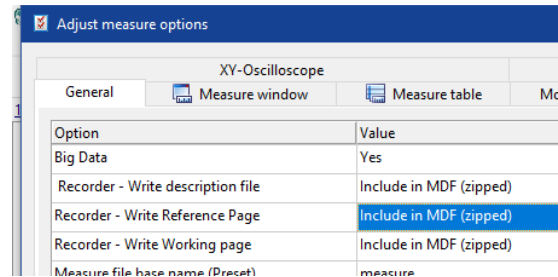

Available with INCA V7.3 SP2

# INCA V7.3 – What's New

## Functionality



### Recorder – Add Calibration Info to support Big Data - Monitoring devices

Add description files to the recorded data on which base the measurement was done

- ECU software description (A2L File)
- Data sets loaded to the ECU (Hex File)
- **New: Bus description files (CAN DB, Autosar)**

With the links in the Meta Data the description files are linked to the related measurements.

INCA adds the description files optionally.

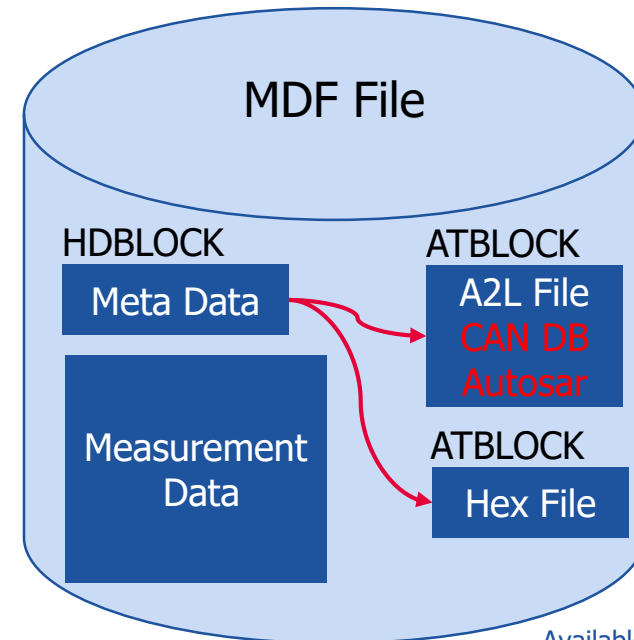
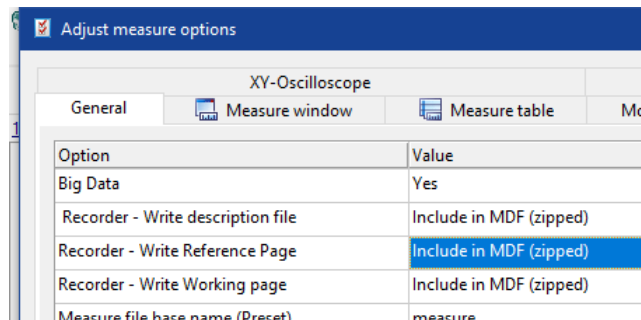

Available with INCA V7.3 SP4

# INCA V7.3 – What's New

## Functionality



### Recorder Configuration – Date/Time, Index, short comment as variables for measure file name (COM-API extensions will be excluded)

- It is possible to use variables for
  - date: dd, MM, yyyy, yy
  - time: hh, HH, mm, ss, tt
  - file counter: CNTx (CNT1, CNT2, ..., CNT10)
- User can type-in the variables or insert the predefined variables sequences with the new UI controls
- The existing experiments will be automatically converted
- The existing COM-API methods are compatible (with limitations)
- New COM-API methods are planned for the new SP
- The file incrementing was changed, so that the „short comment“ is possible on the right of CNTx

The screenshot shows the 'Output File' configuration tab in the INCA software. It includes fields for 'Path' and 'File' name, both containing variables like [MEASUREPATH], [dd], [MM], [yyyy], [hh], [mm], [ss], and [tt]. There are also controls for 'Insert date/time into file name' with a format dropdown set to 'dd-mm-yyyy' and 'Insert auto increment into file name' with an 'Increment digits' spinner set to 1.

Available with INCA V7.3 SP6



# INCA V7.3 – What's New

## Functionality



## Recorder – MDF V4 – Add Signal precision by ASAP2 Format information

### ASAP2 Format

Not all signals need the same precision. To show the needed precision the format information can be used

- INCA adds the format information from the ASAP2 description to the MDF file
- INCA uses the format from the ASAP2 COMPU\_METHOD
- If the ASAP2 file states additional FORMAT information INCA adds this too

[Available with INCA V7.3 SP7](#)



### ES4xx – Import of channel parameters using a csv file

Configuring many channels for ES4xx devices can be done at once

- CSV files are used to define content
- New devices are added to the hardware configuration
- Existing devices are modified
  - Device name, serial number or alias name used to identify device

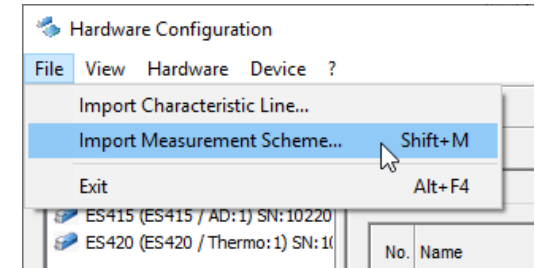

Supported devices:

- ES410
- ES411
- ES413
- ES415
- ES420
- ES421

	A	B	C	D	E	F	G	H	I	J	K	L
1	#deviceType	#HWItemName	#etasSerialNumber	#HWItemAliasName								
2	ES410	ES410 / AD:1	1236546									
3	#index	#name	#unit	#rate	#digitalFilterActive	#filterFrequency	#physMin	#physMax	#sensorMin	#sensorMax	#wantedRangeMin	#wantedR
4	1	ES410_AD1_CH1	V	0,1	0	40	0	60	0	60	0	0
5	2	ES410_AD1_CH2	V	1	0	8	0	60	0	60	0	0
6	3	ES410_AD1_CH3	V	10	1	4	0	60	0	60	0	0
7	4	ES410_AD1_CH4	V	50	1	20	0	22,6	0	40,5	0	0
8	5	ES410_AD1_CH5	V	1000	1	auto	0	60	0	60	0	0
9	6	ES410_AD1_CH6	V	2000	0	8	0	60	0	20,3	0	0
10	7	ES410_AD1_CH7	V	200	0	4	0	55,1	0	60	0	0
11	8	ES410_AD1_CH8	V	500	1	std	0	60	0	60	0	0

Available with INCA V7.3 SP2

# INCA V7.3 – What's New

## Functionality



### XETK/FETK Overload Error Behavior Configuration in INCA

The Overload Error Behavior of an XETK/FETK can be configured in the INCA Hardware Configuration:

- **Stop Measurement:** As soon as the device runs into an overload during measurement it stops the measurement (default behavior).
- **Drop Data and Continue Measurement:** As long as the device is in overload during measurement it drops data packets until it is able to send packets to the PC again. The measurement does not stop.

2 Parameters		3 Info		4 XETK Parameters	
XETK					
BR_XETK-S3					
Autostart Behavior			Last Active Page		
Overload Error Behavior			Stop Measurement		
Code Check Error Behavior			Stop Measurement		
Timers					
40: timer_raster_01 [µs]			100		
39: timer_raster_02 [µs]			1000		
28: timer_raster_03 [µs]			10000		
17: timer_raster_04 [µs]			100000		

Available with INCA V7.3 SP5

# INCA V7.3 – What's New

## Functionality

### ETK – Advanced Code Check

If the Advance Code Check fails while ETK initialization, the ECU software and the INCA project do not fit together. **Every further ECU access must be avoided** in order to avoid unpredictable and possible serious failures (1).

The user has now two possibilities:

**Cancel** stops further initialization and interaction with the ECU. Use this to change the INCA project.

**Continue** stops further access to the ECU but opens the memory page manager in order to flash the ECU according the INCA project.

In this case **no** checksum calculation (read access) can be performed.

(1) Older INCA versions ignore this upon pressing Continue, which lead to an unpredictable result.

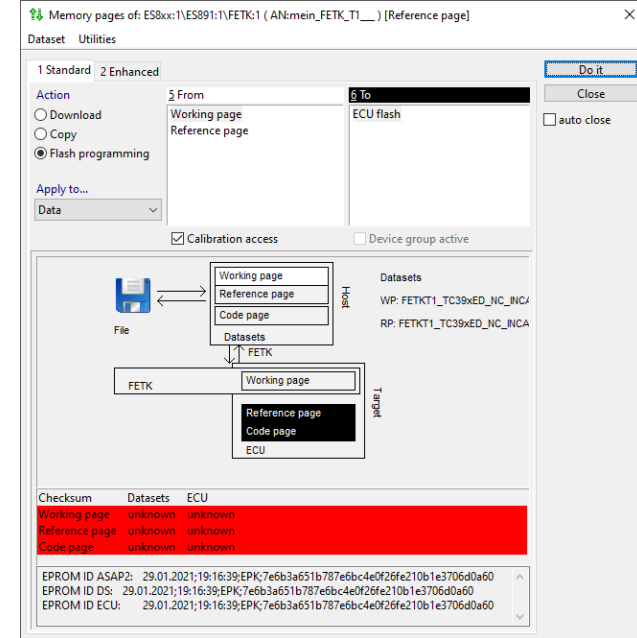
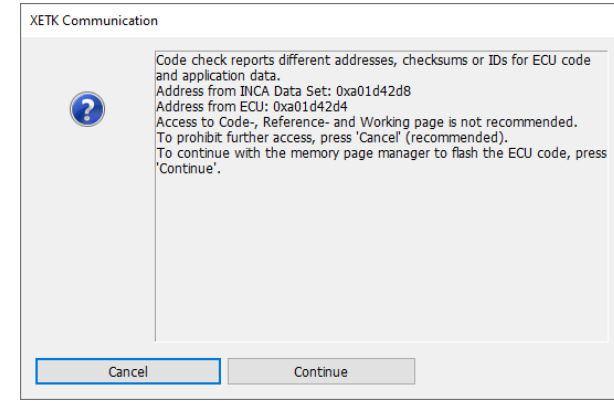

Available with INCA V7.3 SP6



### Multi Session Support on Ethernet ports

- Supported for ES886, VN56x0
- Configuration of multiple instances of SOME/IP and Ethernet Monitoring in parallel below an ETH(x) node in the HWC.
- Main use case: Measuring of SOME/IP and Ethernet Monitoring in parallel

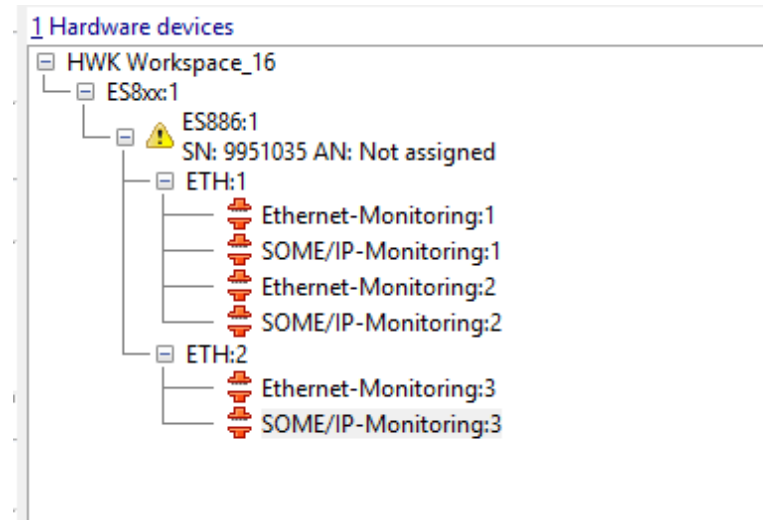



### **“Download Differences” is possible when Reinitializing Automatically with WP Download**

Precondition: INCA supports “Download Differences” for the used protocol in the memory page manager dialog.

- If the workspace in INCA is configured to reinitialize automatically with download of the working page, INCA now checks whether it is possible to download differences only or to execute a complete download of the full WP dataset (previous default behavior).
- INCA checks if the checksums of RP(INCA), RP(ECU) and WP(ECU) are identical to detect which bytes have to be downloaded.
- Faster re-init behavior of INCA for manual usage, testbeds and HIL use cases.

# INCA V7.3 – What's New

## Functionality



## DoIP – Measurement and Calibration over UDS on Ethernet

- INCA 7.3.1 now supports **M**easurement, **C**alibration, **D**iagnostics (with INCA-ODX Add-on) and **F**lashing via DoIP according to ISO13400-2 (**D**iagnostic Communication over **I**P - UDS on Ethernet)
- Prerequisites: A2L file with `IF_DATA ASAP1B_DIAGNOSTIC_SERVICES` section containing the DoIP communication parameters according to the new AML V320 (template available from ETAS)
- To use DoIP with INCA or ODX-LINK, a DoIP device has to be configured in the HWC below an ES886 or Ethernet System and an A2L project has to be assigned
- All known UDS measurement modes are supported for DoIP. INCA will use the same UDS service sequences as for UDS on CAN/CANFD:
  - Address Mode
  - Block Mode
  - Free Running Mode

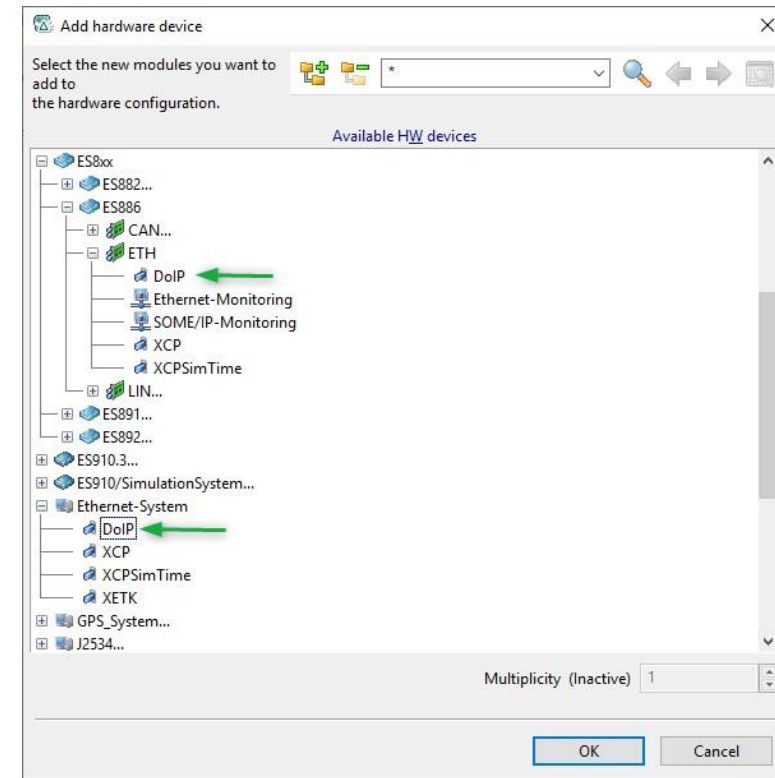

Available with INCA V7.3 SP1



### UDS on FlexRay Flashing with AUTOSAR file

- INCA supports UDS on FlexRay flashing since INCA 7.1.3 based on FIBEX input file
- INCA 7.3.3 now also supports UDS on FlexRay flashing with AUTOSAR 4.x files
- Configuration:
  - Use an AUTOSAR 4.x file for the FLX controller configuration in the INCA HW Configuration
  - Use a ProF Configuration for UDS on FLX flashing
  - The .cnf file of the ProF Configuration must contain the FLX controller ID of the AUTOSAR file
  - The .cnf file of the ProF Configuration must contain the TP configuration for UDS on FLX (extracting the TP configuration from AUTOSAR is not supported)
- Updated ProF documentation available at the ETAS MCD support



# INCA V7.3 – What's New

## Functionality



## AUTOSAR – End to End communication protection (E2E) for SOME/IP

There are several defined E2E profiles, each of it implements a combination of E2E protection mechanisms such a sequence counters, data IDs and CRCs.

Inca supports extracting Payload from the right position

INCA will not check any information from the E2E Header.

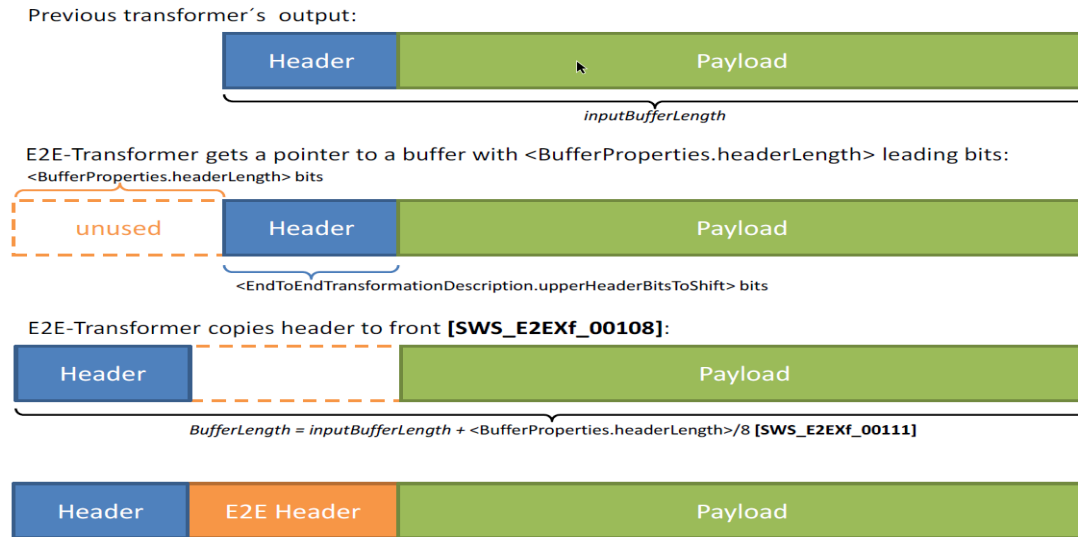

Figure 7-2: Buffer handling of E2EXf\_<transformerId>

(Specification of Module E2E Transformer AUTOSAR CP Release 4.4.0 page 23)

Available with INCA V7.3 SP1

# INCA V7.3 – What's New

## Functionality



### AUTOSAR – Referenced Autosar files

- Autosar offers a number of standard Autosar files which can be referenced in another Autosar file, e.g. for units (AUTOSAR\_MOD\_AISpecification\_Unit\_Standard.arxml).
- INCA allows now to read in one Autosar file with several of these Autosar specification files via multi select.
- INCA creates a MultipleAutosarFileContainer for that in the database that shows all supported Clusters (more than one Autosar file, new icon).
- On container level INCA shows the list of used Autosar files.

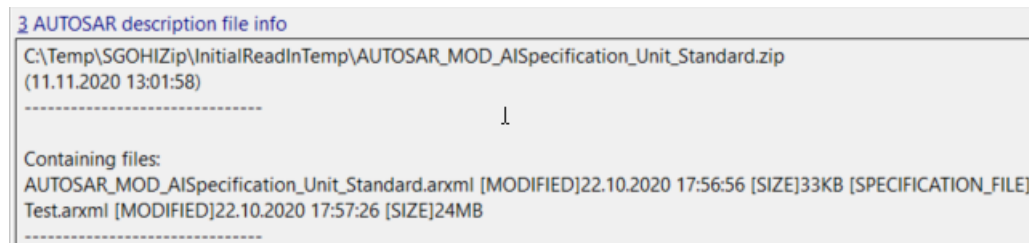
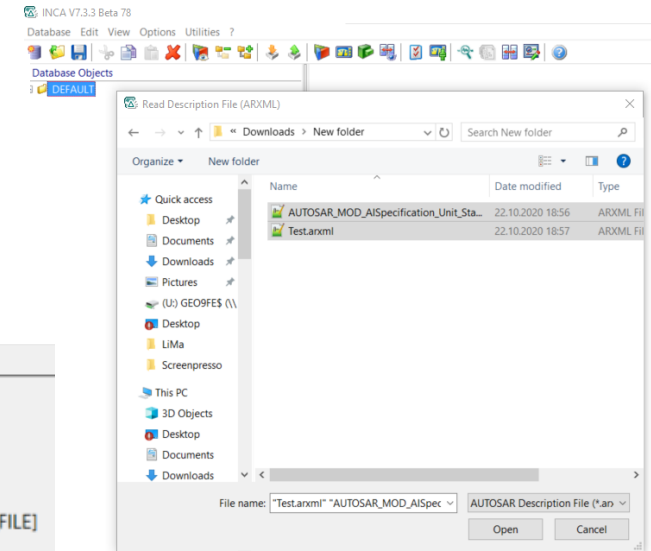
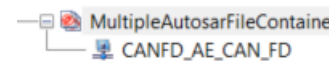

Available with INCA V7.3 SP3

# INCA V7.3 – What's New

## Functionality



### **AUTOSAR – Multiple Sub-Description Files**

- INCA supports the combination of several Autosar ECU extract files
- The user can select several ECU extract files via multiselect to create an Autosar container in the INCA database
- Inca supports CAN, CAN-FD, Flexray and SecOC cluster with the feature up to now
- Only Autosar files with an Extract version can be combined in INCA to one MultipleAutosarFileContainer
- This feature can be combined with “Referenced Autosar files”
- On container level INCA shows the list of used Autosar files
  
- Ethernet and SOME/IP cluster will be supported in future

[Available with INCA V7.3 SP3](#)

# INCA V7.3 – What's New

## Functionality



### **Autosar – Support of multiple ECU extract files – Some IP Monitoring**

- Merging ECU extract files now supports all cluster types which are supported by INCA
- CAN
- CAN-FD
- SecOC (CAN/CAN-FD)
- Flexray
- Ethernet Monitoring
- Some/IP Monitoring (new)

[Available with INCA V7.3 SP6](#)



### **AUTOSAR – Multiple Byte elements for I\_SIGNAL\_TYPE ARRAY**

- Supported for CAN/CAN-FD/FLX and Ethernet Monitoring
- Length must be a multiple of 8
- All elements are having UINT8 as base data type
- INCA creates an array of measurements for such an I-SIGNAL

The I-SIGNAL-TYPE is ARRAY

```
<I-SIGNAL>                                     I
  <SHORT-NAME>TEST</SHORT-NAME>
  <I-SIGNAL-TYPE>ARRAY</I-SIGNAL-TYPE>
  <LENGTH>48</LENGTH>
```

# INCA V7.3 – What's New

## Functionality

### AUTOSAR – V4.4 Support

INCA supports importing Autosar description files with the V4.4 scheme

No additional functionality added to INCA with this version



Description file / Transport layer		Monitor							MC F	F	
Desc. File	Version	CAN	CAN-FD	J1939	LIN	Ethernet/AETH		FlexRay	XCP on Flexray	UDS on Flexray	
						DoIP	Some/IP				
AUTOSAR	3.0	NS	NA	NS	NS	NA	NA	NS	NS	NS	
	3.1	V7.3.0	NA	NS	NS	NA	NA	NS	NS	NS	
	3.2	V7.3.0	NA	NS	NS	NA	NA	V7.3.0	V7.3.0	NS	
	4.1	OK	OK	NS	NS	NS	NS	OK	V7.2.12	NS	
	4.2	OK	OK	NS	NS	NS	NS	OK	V7.2.12	NS	
	4.3.0	OK	OK	NS	NS	V7.2.14	NS	V7.2.15	OK	V7.2.12	NS
	4.3.1	V7.2.11	V7.2.11	NS	NS	V7.2.14	NS	V7.2.15	V7.2.11	V7.2.12	NS
	4.4.0	V7.3.1	V7.3.1	NS	NS	V7.3.1	NS	V7.3.1	V7.3.1	V7.3.1	NS
	R19-11	NS	NS	NS	NS	NS	NS	NS	NS	NS	NS
FIBEX	1.1.5a	NS	NA	NA	NS	NA	NA	NA	V7.3.0	V7.3.0	V7.3.0
	1.2.0a	NS	NA	NA	NS	NA	NA	NA	V7.3.0	V7.3.0	V7.3.0
	2.0.0	NS	NA	NA	NS	NA	NA	NA	V7.3.0	V7.3.0	V7.3.0
	2.0.1	NS	NA	NA	NS	NA	NA	NA	V7.3.0	V7.3.0	V7.3.0
	FIBEX+	NS	NA	NA	NS	NA	NA	NA	V7.3.0	V7.3.0	V7.3.0
	3.0	NS	NA	NA	NS	NA	NA	NA	V7.3.0	V7.3.0	V7.3.0
	3.1	NS	NA	NA	NS	NA	NA	NA	OK	OK	OK
	4.1.0	NS	NS	NA	NS	NS	NS	NS	NS	NS	NS
	4.1.1	NS	NS	NA	NS	NS	NS	NS	NS	NS	NS
4.1.2	NS	NS	NA	NS	NS	NS	NS	NS	NS	NS	
CAN DBC		OK	OK	OK	NA	NA	NA	NA	NA	NA	
J1939 DBC		NA	NA	OK	NA	NA	NA	NA	NA	NA	
LDF	1.2	NA	NA	NA	OK	NA	NA	NA	NA	NA	
	1.3	NA	NA	NA	OK	NA	NA	NA	NA	NA	
	2.0	NA	NA	NA	OK	NA	NA	NA	NA	NA	
	2.1	NA	NA	NA	OK	NA	NA	NA	NA	NA	
	2.2	NA	NA	NA	OK	NA	NA	NA	NA	NA	

- OK Feature available in INCA
- NA Not applicable
- NS Not supported
- V7.3.0 Not supported anymore

Available with INCA V7.3 SP1

# INCA V7.3 – What's New

## Functionality



### **AUTOSAR – Release 19-11**

- INCA supports the new AUTOSAR schema
  - with already supported functionality
  - no additional functionality implemented

Available with INCA V7.3 SP3

# INCA V7.3 – What's New

## Functionality



### AUTOSAR – Support of additional group filter

- An Autosar file can describe several physical Ethernet channels in one file.
- The user wants to see only the signals of the physically connected Ethernet cable.
- In the INCA variable selection dialog the user can now filter for the different physical ethernet channel and sees only the corresponding signals.
- Different physical ethernet channel are having different Vlan identifier typically.



Available with INCA V7.3 SP4





### **Enhanced A2L/Autosar check for Flexray buffer configuration XCP Master**

- INCA still checks if the XCP frame/slot configuration between Autosar file and a2l fits together.
- No special XCP master node is needed anymore.
- At least one FLX controller of the cluster has to describe the FLX frames and PDUs, and it doesn't matter whether for the XCP master or for the XCP slave. Now INCA extracts the relevant data from the Autosar file and creates its own internally configuration. The user can select any controller of the cluster to get XCP on FLX running.

# INCA V7.3 – What's New

## Functionality



## Support of multiple Autosar ECU extract files 3<sup>rd</sup> release

- Support up to 255 Autosar Extract files in one INCA container.
- Already supported cluster: CAN, CAN-FD, FLX
- **New:** Support of Ethernet Cluster.

The screenshot shows the INCA software interface. On the left, the 'Database Objects' tree is expanded to show a 'MultipleAutosarFileContainer\_AC1.1.4\_CAN\_ETH\_FLX' container. Inside this container, several Ethernet clusters are listed: 'ETH\_EthernetCluster\_1', 'ETH\_EthernetCluster\_2', 'ETH\_EthernetCluster\_3\_Multi\_VLAN', and 'ETH\_EthernetCluster\_5\_PduAndSIP'. A red bracket highlights these four clusters, with the text 'SP5' next to it. On the right, the 'Containing Files' table lists the files associated with these clusters.

Name	Extract version	Schema versio	Date modified	Size	Type
AUTOSAR_MOD_AISpecification_PhysicalDimension_Standard.	-	4.4.0	29.10.2020 18:38:26	9KB	SPECIFICATION_FILE
AUTOSAR_MOD_AISpecification_Unit_Standard.xml	-	4.4.0	29.10.2020 18:38:26	21KB	SPECIFICATION_FILE
ECU1_CAN_SystemExtract.xml	\$Id: ECU1_CAN_SystemExtract.xml 3901 2021-04-30 12:30:03Z mkl9fe \$	4.4.0	30.04.2021 14:30:03	1161KB	STD_FILE
ECU1_ETH_SystemExtract.xml	\$Id: ECU1_ETH_SystemExtract.xml 3901 2021-04-30 12:30:03Z mkl9fe \$	4.4.0	30.04.2021 14:30:03	1222KB	STD_FILE
ECU2_FlexRay_KS14_SystemExtract.xml	\$Id: ECU2_FlexRay_KS14_SystemExtract.xml 3901 2021-04-30 12:30:03Z mkl9fe \$	4.4.0	30.04.2021 14:30:03	1364KB	STD_FILE

Below the table, the 'AUTOSAR description file info' section shows the file paths for the files listed in the table.

Available with INCA V7.3 SP5

# INCA V7.3 – What's New

## Functionality



### AUTOSAR – I-SIGNAL Array Support (ISO8859-1 encoding)

- INCA 7.3.3 supports byte arrays with no encoding
- For Autosar COM Transformer based monitoring devices
  - Can(Fd), FlexRay and Ethernet PDU Monitoring
- INCA doesn't support encodings for measurements
  - ISO 8859-1 is a single byte encoding
  - Encoding is mapped on a VTAB compu method in INCA database
  - Compu methods defined in AUTOSAR are ignored for these signals

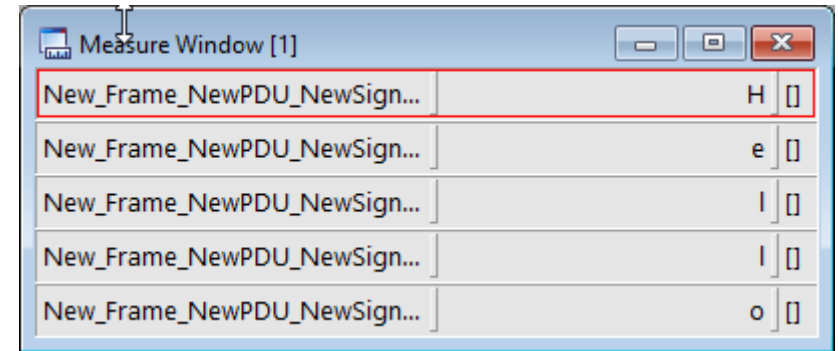

Available with INCA V7.3 SP7



## ODX Snapshot execution via INCA COM API

- The ODX-LINK Snapshot functionality is now available at the INCA COM API
  - `Bool IncaOnlineExperiment.PerformODXSnapshot()`
- The API function can only be used, if an ODX project is open in the Experiment
- The API snapshot will use the settings of the ODX-LINK Data Logging configuration window, which defines e.g. the filename of the snapshot and the snapshot header data
- The API function only makes sense in conjunction with the ODX-LINK OBD window, because this is the only ODX-LINK window that will refresh its diagnostic data automatically when the snapshot is triggered
- The new function is documented in "INCA7.3\cebra\INCA Tool-API Documentation.chm"

# INCA V7.3 – What's New

## Functionality



## Updated OBD and WWH-OBD ODX projects according to latest SAEJ1979-DA 2019-05

Mode 1 and 2: New PIDs \$AA - \$B0 and changes to PIDs \$51, \$8B, \$95-9C, \$A4, \$A8

Mode 6: New MIDs \$3E and \$3F and changes to MIDs \$51 - \$54

Mode 6: New Unit and Scaling IDs \$93 and \$AA and changes to IDs \$3D, \$85, \$86, \$8A, \$8D, \$8E, \$FC, \$FD

Mode 8: New Test Routine \$03

Mode 9: New InfoTypes \$40 - \$78 and changes to InfoTypes \$0A and \$18

- All new Mode 1 and Mode 2 PIDs and Mode 9 InfoTypes with physical response values are available as Measurement Signals in the Variable Selection Dialog
- The OBD Window displays all new data (if supported by the vehicle) when used with the new ODX project

The new ODX projects get installed with the INCA-ODX Addon into the folder ETASData\ODX7.3\Projects:

- OBDOnCAN\_ETAS\_SAEJ1979\_2019-05.pdx
- WWH\_OBD\_ETAS\_SAEJ1979\_2019-05.pdx
- To use the new functionality, the new ODX projects have to be imported into INCA and assigned to a Workspace with an OBDOnCAN device (or an UDS device for WWH-OBD)

Available with INCA V7.3 SP4



### **XCP – Calibration Method "Autosar Single Pointer Calibration"**

- Update:
  - INCA will send the standard XCP command SET\_CAL\_PAGE/GET\_CAL\_PAGE for page switching even if the access in the ECU is implemented via a single pointer table for both pages.
  - The Ecu has to handle the SET-/GET\_CAL\_PAGE request consistently.
  - Additionally INCA will always download the corresponding pointer for WP or RP to this single pointer table in RAM.
  - For the time of this download the pointer table itself could be inconsistent with a mixture of WP and RP pointer. This is related to this specific calibration concept.
  - The time of inconsistency depends on Transport Layer and size of the pointer table.

# INCA V7.3 – What's New

## Functionality



### XCP – AUTOSAR Single Pointer Method – single page, checksum by INCA

Supports now

- XCP one page concept
- No original pointer table available

One Page Concept: no XCP SET\_CAL\_PAGE

Different Cal\_Groups

Cal\_Groups

Single Pointered

```

CALIBRATION_METHOD AUTOSAR_SINGLE_POINTERED
Size      Start      End      PointeredTable
0x18      [0x800000 .. 0x800017]  (1 / 6 entries)
Size      Start      End      PoolRAM fill level
0x2000    [0x880000 .. 0x881FFF] (24 Bytes 0%)

Flash      PoolRAM    Size % Fill  Groupname
0x76567D10 0x880000    0x18      0      P_S32_1_APT_Cal_Measure_PtrTabGrp
    
```

Available with INCA V7.3 SP4

# INCA V7.3 – What's New

## Functionality



## XCP – DAQ configuration optimization - optimize ODT entries to save RAM

- With this option enabled INCA tries to combine measurements to one ODT entry if possible to get a smaller configuration for the Ecu.
- Prerequisite (a2l file):
  - Optimization mode: default
  - Address extension: free
  - no gaps between measurements
- Default setting:
  - Disabled

Hardware: >Workspace\_3< Experiment: >NewExp<  
File Hardware Device Channels View MCE ?

1 Hardware devices  
HWK Workspace\_3  
Ethernet-System:1  
XCP:1  
ECU OFF/No init./no ECU access

2 Parameters 3 Info  
XCP  
Option Value  
Name XCP:1  
Meas. failure behavior Abort after failure  
Time stamp quantizati Off  
Connection behavior Reinitialize automatically  
Project working data Example for A2L incl. ECU Documentation\XCP\_Test\_File  
Reference Data Empty Dataitem  
Differences (bytes) 0  
Transport Layer Instance IPv4  
Ethernet Address (IPv4) 127.0.0.1  
Destination Port 9001  
Source Port  
Ethernet Protocol Type UDP-IP  
Log out behavior No Automatic Flash Back  
ECU Description Handling ECU  
Seed'n Key DLL  
Seed'n Key Privileges 0 DAQ, 0 CAL/PAG, 0 STIM, 0 PGM  
Checksum DLL  
Fast Start Fast start enabled: No  
ECU Connect Mode NORMAL  
Confirm page switch Yes  
DAQ optimization ODT entries  
Counter Consistency Mode one counter for all CTOs+DTOs  
Name of the device  
Apply

Available with INCA V7.3 SP6



# INCA V7.3 – What's New

## Functionality



### XCP V1.4 – Packed DAQ Lists (DAQ Packed Mode)

**Target:** Reduce the number of interrupts of the controller/ECU and measure with faster Events.

Reduce overhead → optimization of busload.

Support for CAN-FD/Ethernet communication for **dynamic** DAQ lists now.

Support of element-grouped and event-grouped packed mode.

EVENT cycle time down to 1µs supported.

PID 0	00:03	A3	B3	C3	D3	E3	F3
PID 1	G3	H3	J3	K3	L3	M3	

Figure 8 Standard DTO format

PID 0	00:03	A0	A1	A2	A3	B0	B1	B2	B3	C0	C1	C2	C3	D0
		C3	D0	D1	D2	D3	E0	E1	E2	E3	F0	F1	F2	F3
PID 1	G0	G1	G2	G3	H0	H1	H2	H3	J0	J1	J2	J3	K0	
	J3	K0	K1	K2	K3	L0	L1	L2	L3	M0	M1	M2	M3	

Figure 9 DTO format in element-grouped packed mode.<sup>1</sup>

PID 0	00:03	A0	B0	C0	D0	E0	F0	A1	B1	C1	D1	E1	F1	A2
		F1	A2	B2	C2	D2	E2	F2	A3	B3	C3	D3	E3	F3
PID 1	G0	H0	J0	K0	L0	M0	G1	H1	J1	K1	L1	M1	G2	
	M1	G2	H2	J2	K2	L2	M2	G3	H3	J3	K3	L3	M3	

Figure 10 DTO format in event-grouped packed mode.<sup>1</sup>

Figures taken from XCP specification V1.4

Available with INCA V7.3 SP1

# INCA V7.3 – What's New

## Functionality



### XCP V1.4 – Consistency event list for measurements

The consistency event list entry for a measurement tells the XCP master

- 1) All measurements which are having the identical consistency event list entry are consistent to each other if the user selects this EVENT for the DAQ configuration.
- 2) The consistency event list entry overrules the default event list entry

In INCA you will not see a difference between Default or Consistency Event List settings, both will be shown as Default Event List.

Name	Data Source	Role	Address	Location	Bytes	Consistency Event	Consistency DAQ	Consistency ODT	Consistency NONE	Poling_100ms	Poling_500ms	Poling_1s
A12_D1_C2	XCP:1		0x69A0	Internal	0x4		<input checked="" type="checkbox"/>					

```
/begin MEASUREMENT
/* Name */      A12_D1_C2
/* LongIdentifier */ ""
/* Datatype */  FLOAT32_IEEE
/* Conversion */ ident
/* Resolution */ 1
/* Accuracy */  100
/* LowerLimit */ -1.e+037
/* UpperLimit */ 1.e+037
ECU_ADDRESS     27040
/begin IF_DATA XCPplus
0x0104
/begin DAQ_EVENT
VARIABLE
/begin AVAILABLE_EVENT_LIST
EVENT 1
EVENT 2
/end AVAILABLE_EVENT_LIST
/begin DEFAULT_EVENT_LIST
EVENT 1
/end DEFAULT_EVENT_LIST
/begin
CONSISTENCY_EVENT_LIST
EVENT 2
/end CONSISTENCY_EVENT_LIST
/end DAQ_EVENT
/end IF_DATA
/end MEASUREMENT
```

Available with INCA V7.3 SP2



### **XCP V1.4 – DATA SIZE in combination with CONSISTENCY EVENT LIST**

- In combination with the consistency mode `CONSISTENCY_NONE` the `DATA SIZE` parameter is relevant to decide whether a signal can be measure consistently or not.
- In addition the Consistency Event List information which can be part of the a2l file is relevant.
- INCA now informs the user which signals are configured in the experiment in such a way that the samples could be inconsistent.
- e.g. 8 byte signal with an ecu which supports only a `DATA SIZE` of 32(bit) and `CONSITENCY_NONE`
  - If this signal is configure in a Consistency Event List event the signal can be measure consistently
  - If this signal is configured for any other `CONSISTENCY_NONE` event the samples are potentially inconsistent



### XCP V1.4 – Consistency NONE

- With Consistency None there is no consistency guarantee on EVENT/DAQ or ODT level.
- Only the ecu itself can guarantee the sampling of measurements up to a specific size.
- DATA\_SIZE is the Asap2 keyword which defines the limit
  - All measurements which are larger are always potential inconsistent and could be cut into 2 ODT entries.
  - All measurements which are smaller or equal to DATA\_SIZE are always consistent and it is not allowed to cut those measurements into two ODT entries. Only with supported XCP measurement split allowed feature by the XCP slave it exists a possibility to measure those measurements consistently with 2 ODT. See next feature.

	XCP Version	OM_Default	OM_ODT_TYPE_16	OM_ODT_TYPE_32	OM_ODT_TYPE_64	OM_ODT_ALIGNMENT	OM_MAX_ENTRY_SIZE
CONSISTENCY EVENT	1.0	V7.1.0	V7.2.1	V7.2.1	V7.2.1	V7.2.0	V7.2.1
CONSISTENCY DAQ	1.0	V7.2.0	V7.2.1	V7.2.1	V7.2.1	V7.2.1	V7.2.1
CONSISTENCY ODT	1.2	CM_EVENT*	V7.2.0	V7.2.0	V7.2.0	V7.2.1	V7.2.1
CONSISTENCY NONE	1.4	V7.3.2	V7.3.2	V7.3.2	V7.3.2	V7.3.2**	not supported
* only without Measurement Split Allowed ==> mapping to CM_EVENT(old behavior)							
** ignores Measurement Split Allowed							

Available with INCA V7.3 SP2



### XCP V1.4 – Efficient DAQ Data Transfer on CAN (MEASUREMENT\_SPLIT\_ALLOWED)

- XCP Specification: With MEASUREMENT\_SPLIT\_ALLOWED at the CAN transport layer of the ASAM MCD-2 MC description file, the slave can indicate that for MEASUREMENT variables, that can be measured consistent within one ODT entry as defined in XCP Protocol Layer, the consistency is also guaranteed by the slave, if they are split into two consecutive ODT entries of two consecutive ODTs.

e.g. 2x Ulong measurements on CAN

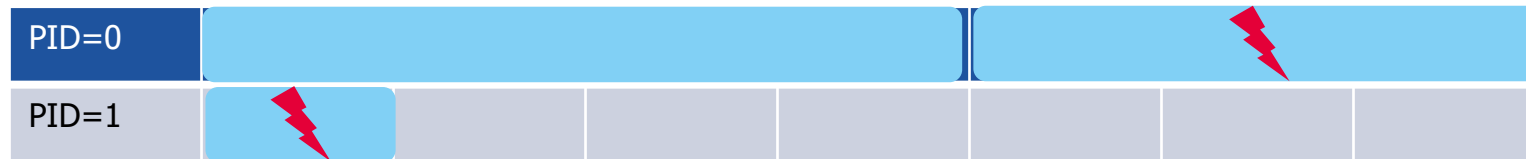

without measurement split allowed.  
⚡ potentially inconsistent

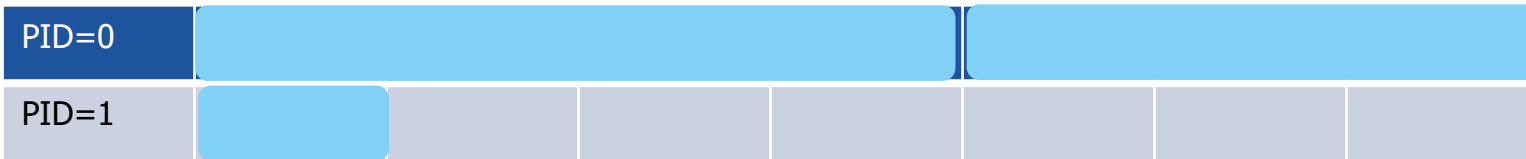

with measurement split allowed

[Available with INCA V7.3 SP2](#)

# INCA V7.3 – What's New

## Functionality



### **XCP V1.4 – DAQ Packed Mode with Predefined DAQ lists**

- Predefined DAQ lists are preconfigured/static DAQ lists which can only be activated in total or not.
- The configuration is part of the a2I file and can not be modified on the fly.
- DAQ Packed Mode is a special measure mode to optimize the interrupt/throughput for fast EVENTS.
- For special use cases it can now be used in combination.

→ High Speed measure modules via Ethernet interface

Available with INCA V7.3 SP2

# INCA V7.3 – What's New

## Functionality



### XCP – Support of HOST\_NAME keyword

- The XCP standard allows to define either an IPv4, IPv6 or the Host name of the Ecu in the a2I file for XCP on Ethernet.
- In the HWC INCA shows the Host name from the a2I and allows to change the Host name manually.
- INCA checks the Host name against the RFC952/1123 specification.
- To resolve the IP address from the Ecu INCA uses the MS OS mechanism.
- Limitation: The result of resolving the IP address has to be unique. IPv4 or IPv6.

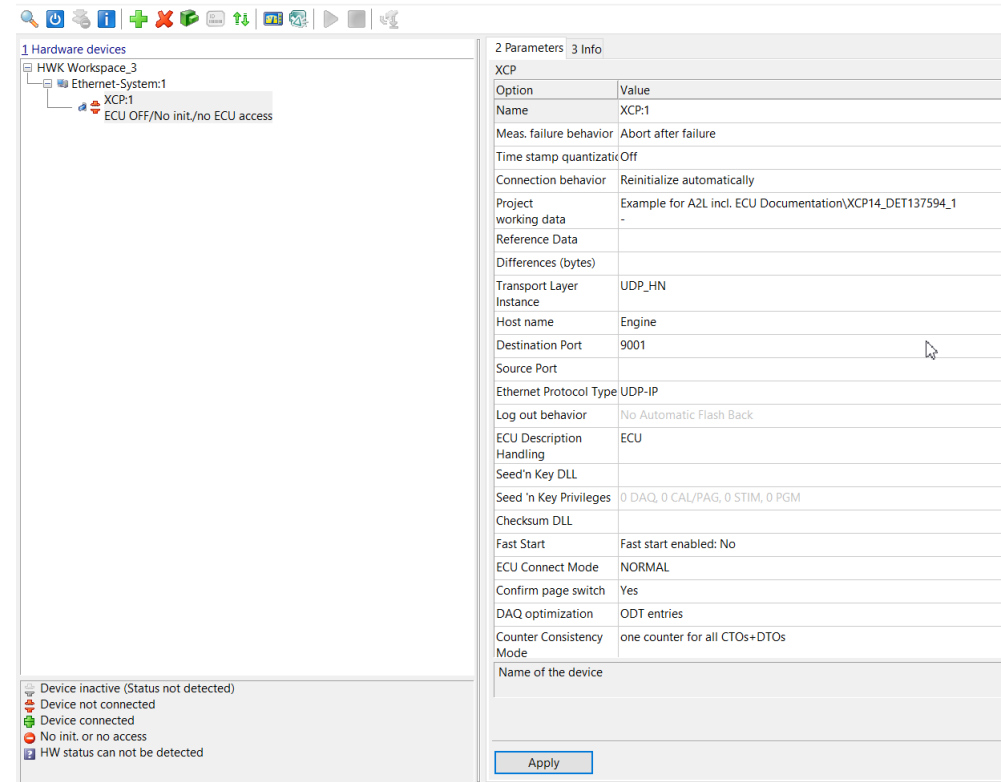

Available with INCA V7.3 SP6

# INCA V7.3 – What's New

## Functionality



## XCP – Resume Mode support via Tool API

INCA allows remote control of the XCP Resume Mode via its COM-API

- INCA re-uses the already supported COM-API methods of CCP Resume Mode

### WorkBaseDevice

- QuickStart\_Disable()
- QuickStart\_Enable()
- QuickStart\_IsQuickStartModeConfiguredInHWC()
- QuickStart\_StoreMeasurementConfigurationInECU()
- QuickStart\_DeleteMeasurementConfigurationInECU()

Option	Value
Name	XCP:1
Meas. failure behavior	About after failure
Time stamp quantization	OFF
Connection behavior	Reinitialize automatically
Project working data	APT\Folder\XCP1DonCAN - Copy
Reference Data	Upload\Upload_2
Differences (Bytes)	Upload\Upload_1
Log out behavior	No Automatic Flash Back
ECU Description Handling	ASAP2
Seed in Key DLL	
Seed in Key Privileges	0 DAQ, 0 CAL/PAG, 0 STIM, 0 PDM
Checksum DLL	
Fast Start	Fast start enabled: No
ECU Connect Mode	NORMAL
Prof. Flash Port	CAN1 (CAN1) / ES11:1
Confirm page switch	Yes
DAQ optimization	disabled
Project CAN baud rate [Baud]	1000000
Check memory pages at initialization	Always check

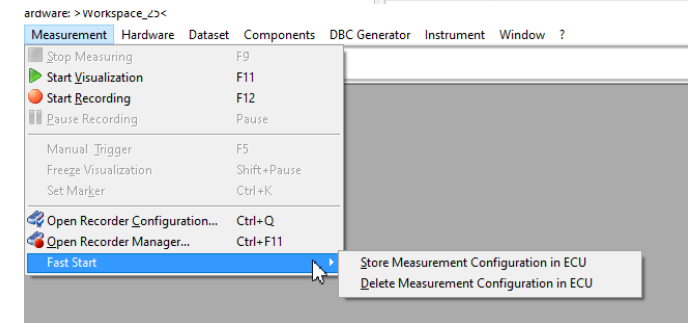

Available with INCA V7.3 SP7



# INCA V7.3 – What's New

## Functionality

### XCP V1.0 – Minimum Raster Check for Dynamic DAQ

- INCA checks that not more than MAX\_EVENT\_CHANNEL EVENTS can be used in the “Variable Selection Dialog”.
- INCA shows the number of used ODTs and DAQs for each EVENT.



All Sources (Not Filtered, 19007/19007 Visible)

Name	Role	Address	Bytes
element_of_data_folder_will_be_removedGd_Measure		0x155972C	0x[1]
BH_Sm116_P_BH_BH_Test		0x31625	0x2
BH_Sm116_BH_00.Extern_HEFLB_Test		0x31605	0x2[0]
BH_Sm116_BH_00.Extern_HEFLB_Test		0x31615	0x2[0]
BH_Sm116_BH_01.Extern_HEFLB_Test		0x31605	0x2[1]
BH_Sm116_BH_01.Extern_HEFLB_Test		0x31615	0x2[1]
BH_Sm116_BH_02.Extern_HEFLB_Test		0x31605	0x2[2]
BH_Sm116_BH_02.Extern_HEFLB_Test		0x31615	0x2[2]
BH_Sm116_BH_03.Extern_HEFLB_Test		0x31605	0x2[3]
BH_Sm116_BH_03.Extern_HEFLB_Test		0x31615	0x[1]
BH_Sm116_BH_04.Extern_HEFLB_Test		0x31605	0x[4]
BH_Sm116_BH_04.Extern_HEFLB_Test		0x31615	0x[4]
BH_Sm116_BH_05.Extern_HEFLB_Test		0x31605	0x[5]
BH_Sm116_BH_05.Extern_HEFLB_Test		0x31615	0x[5]
BH_Sm116_BH_06.Extern_HEFLB_Test		0x31605	0x[6]
BH_Sm116_BH_06.Extern_HEFLB_Test		0x31615	0x[6]
BH_Sm116_BH_07.Extern_HEFLB_Test		0x31605	0x[7]
BH_Sm116_BH_07.Extern_HEFLB_Test		0x31615	0x[7]
BH_Sm116_BH_08.Extern_HEFLB_Test		0x31605	0x[8]
BH_Sm116_BH_08.Extern_HEFLB_Test		0x31615	0x[8]
BH_Sm116_BH_09.Extern_HEFLB_Test		0x31605	0x[9]
BH_Sm116_BH_09.Extern_HEFLB_Test		0x31615	0x[9]
BH_Sm116_BH_10.Extern_HEFLB_Test		0x31605	0x[10]
BH_Sm116_BH_10.Extern_HEFLB_Test		0x31615	0x[10]

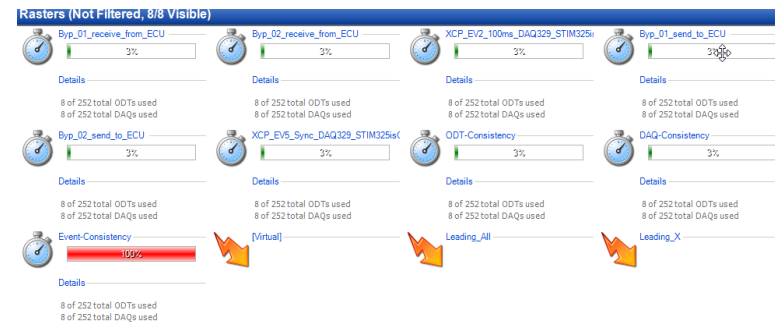

Available with INCA V7.3 SP7

# INCA V7.3 – What's New

## Functionality



### Prof – XCP on FlexRay Flashing

#### Prerequisites

- A2I file for XCP on FlexRay description
- Autosar file with PDUs and Frames for XCP
- Prof Configuration

#### Supported XCP communication modes

- XCP handshake mode
- XCP block mode with  $MIN\_ST\_PGM = 0$

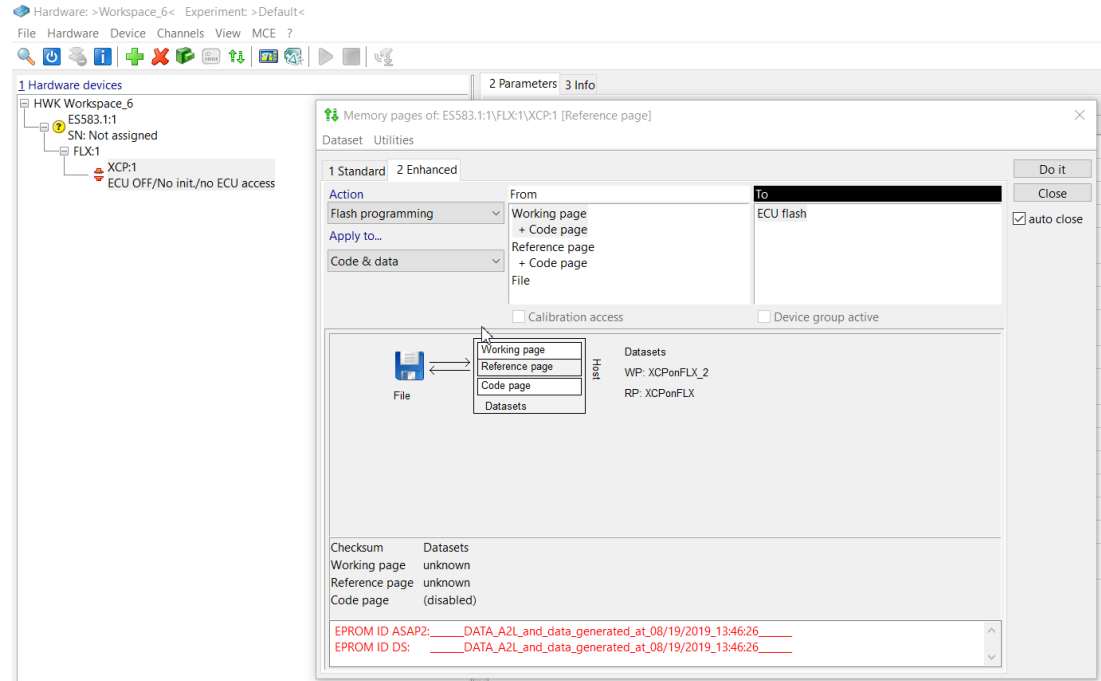

# INCA V7.3 – What's New

## Functionality



## Ethernet/SOME\_IP Monitoring on local network cards

INCA supports local network cards for Some/IP and Ethernet monitoring interface.

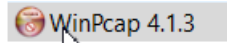

This feature prerequisites the manually installation of WinPcap V4.1.3

To receive Jumbo frames or VLAN tagged frames additional network card specific setting could be needed.

Network cards with not unique MAC address will be ignored (e.g. virtual network loop back adapter).

Network cards with DHCP IP address will be ignored.



Available with INCA V7.3 SP1

# INCA V7.3 – What's New

## Functionality



## Vector Ethernet Network Support (Network-based mode), enabling SomeIP and PDU (Ethernet) Monitoring

- The Network-based mode is an abstraction of a network via a unique network name, no single channels anymore. The complete access to the network is done via the network name.
- All configuration settings like ports settings must be done in advance in the Vector Hardware Configuration tool, in INCA there is no possibility to change the setup.
- In INCA such networks are represented as Vector Ethernet Network system.
- INCA uses the network name as unique identifier in the serial number field.
- The XCP support is planned for Q1/2022.
- A valid SW license is required.
- Supported HW: All Vector hardware supporting the Network-Based mode.
- Tested Vector HW: VN5240, VN5610(A), VN5620, VN5640 and VN5650.

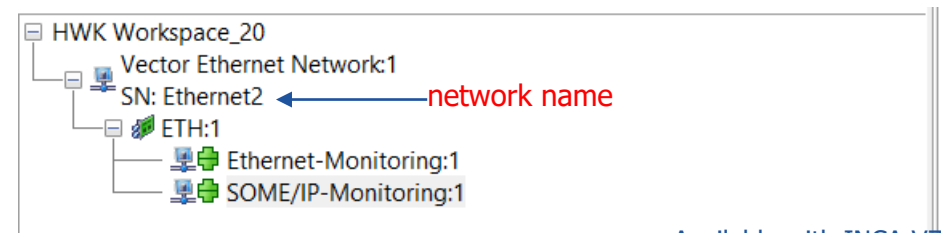
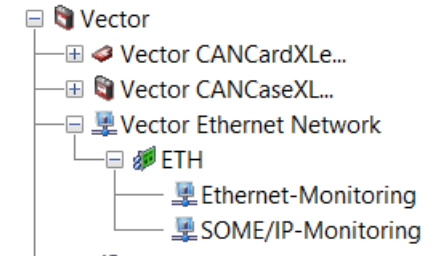

Available with INCA V7.3 SP7

# INCA V7.3 – What's New

## Functionality



### Allow more than one CAN-Monitoring device below CAN/CAN-FD node

INCA supports now up to 4 descriptions files on 1 physical CAN/CAN-FD channel

- Supported are dbc and Autosar files
- The configuration can contain a mixture of these kind of files

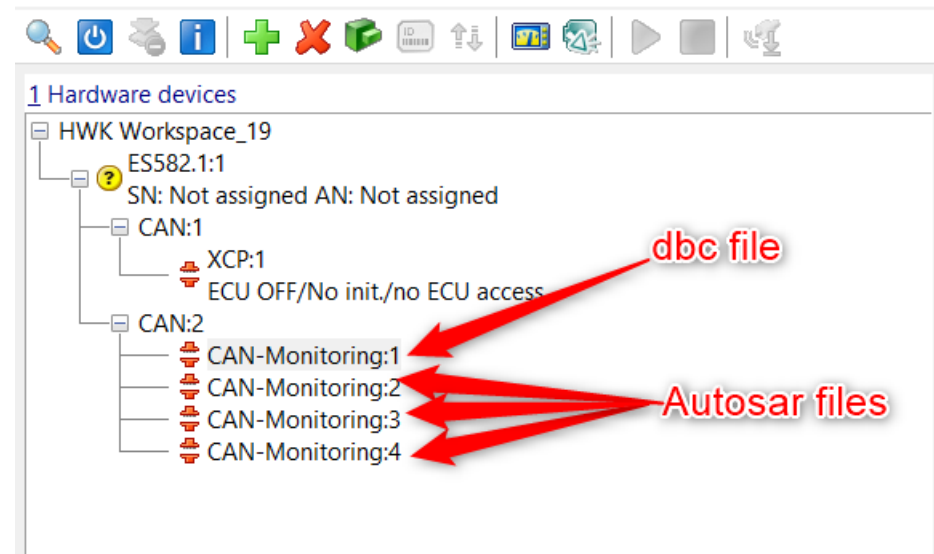

Available with INCA V7.3 SP1

# INCA V7.3 – What's New

## Functionality



### ASAP2 – DISCRETE

When signals are measured that have only dedicated values it makes sense that e.g. an oscilloscope displays only the discrete values and does not interpolate between two measure samples

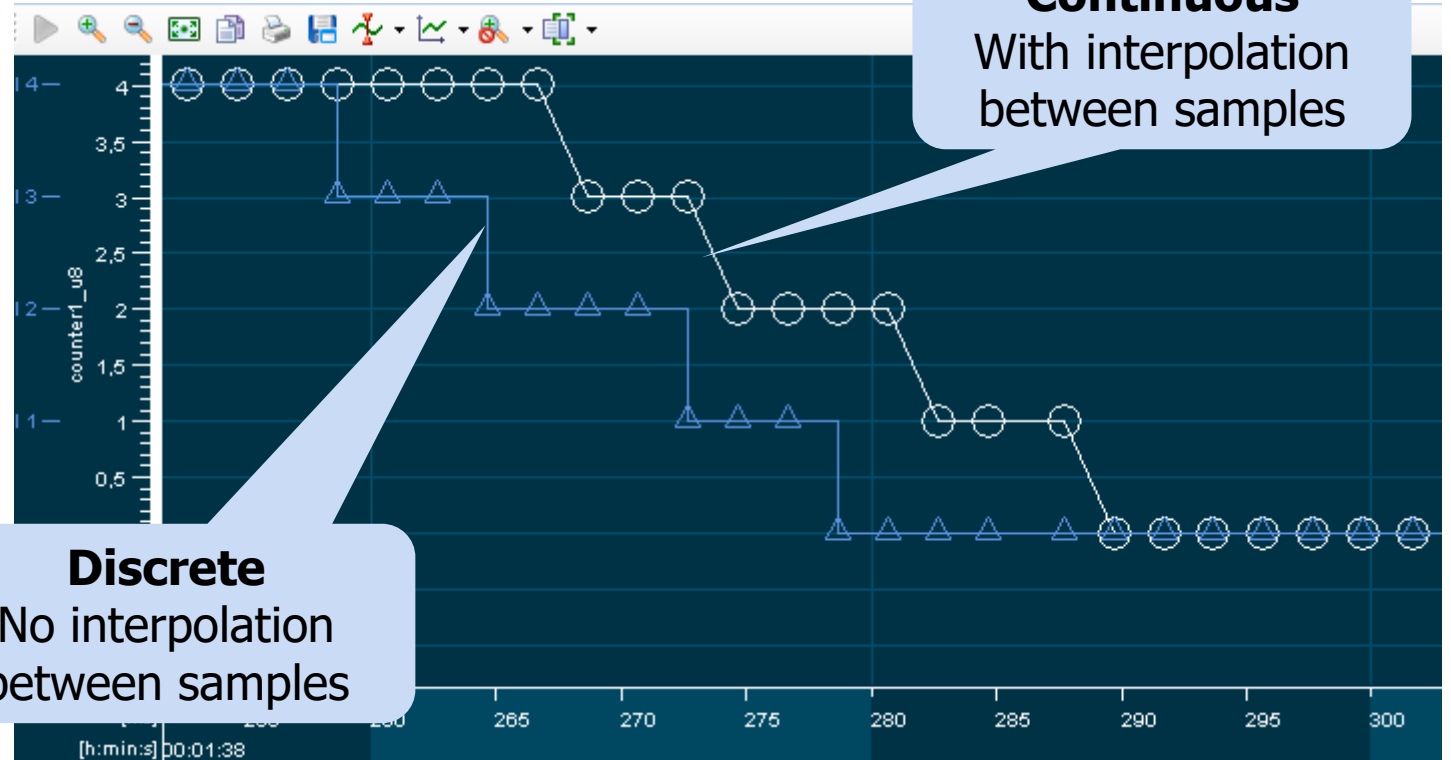

Available with INCA V7.3 SP3

# INCA V7.3 – What's New

## Functionality



## ASAP2 – Keyword CALIBRATION\_ACCESS

### CALIBRATION\_ACCESS modes



#### **CALIBRATION**

calibration allowed



#### **NO\_CALIBRATION**

calibration NOT allowed



#### **NOT\_IN\_MCD\_SYSTEM**

not writable nor readable by the MCD-System



#### **OFFLINE\_CALIBRATION**

calibration only while the MCD-System is offline

### Asap Editor

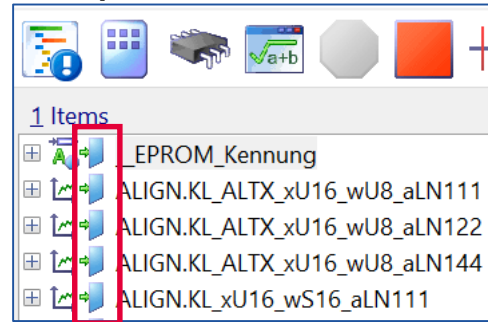

CALIBRATION\_ACCESS

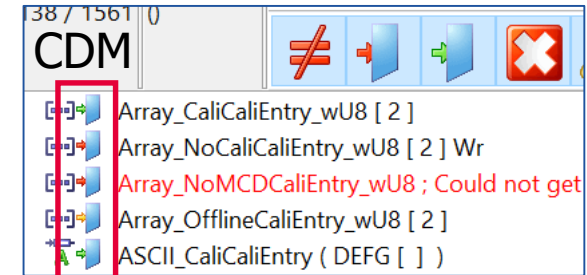

### VSD

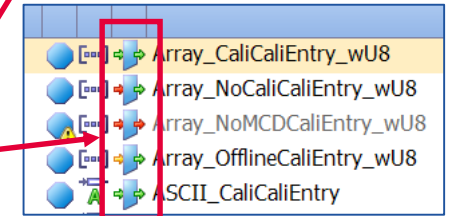

The ASAP2 keyword CALIBRATION\_ACCESS can be used as an alternative to the ASAP2 keyword READ\_ONLY

Available with INCA V7.3 SP5

# INCA V7.3 – What's New

## Functionality



### **ASAP2 – Keyword `ALIGNMENT_FLOAT16_IEEE`**

INCA supports the keyword `ALIGNMENT_FLOAT16_IEEE` that defines how `FLOAT16_IEEE` objects are located in the ECU MEMORY.

The ASAP2 data type `FLOAT16_IEEE` itself is not supported!

[Available with INCA V7.3 SP5](#)



# INCA V7.3 – What's New

## Functionality



### Clustering of ECUs in the EE

- To switch multiple devices between working and reference page INCA supports a clustering of ECUs
- The Leading Device defines the page used at start of clustering

Cluster Information in the Experiment

"Leading Device" marked in **BOLD**

Device	WP	RP	Diff.
<b>ETK test device:1</b> 428_XETKT21_XETKV10_ETKT21_TC1797_NC_TSEG_XAML110_D13D13TDM_ACC	<b>WP: XETKT21_TC1797_NC_TSEG_1</b>	RP: XETKT21_TC1797_NC_TSEG	Diff.: 30
ETK test device:2 428_XETKT21_XETKV10_ETKT21_TC1797_NC_TSEG_XAML110_D13D13TDM_ACC_otherRaster	<b>WP: XETKT21_TC1797_NC_TSEG_2</b>	RP: XETKT21_TC1797_NC_TSEG_1	Diff.: 0
ETK test device:3 Demo07	<b>WP: Demo07_2</b>	RP: Demo07	Diff.: 0
ETK test device:4 Demo08	WP: Demo08_2	<b>RP: Demo08</b>	Diff.: 0
Offline device:1 Demo09	<b>WP: Demo09_2</b>	RP: Demo09	Diff.: 2 ECU OFF - No access

Available with INCA V7.3 SP3

# INCA V7.3 – What's New

## Functionality



## Support of Vector virtual CAN

- vCAN supports the CAN and CAN-FD.
- vCAN supports only real time use cases.
- Not supported by ES820
- INCA\_VECTOR\_HW subscription license required to use vCAN in INCA

Description	License	F-Number	Feature
Machine-named license for Vector HW Support for INCA , 1 year subscription	ISW_VHW_LIC-MS	F-00K-112-885	INCA_VECTOR_HW
User-named license for Vector HW Support for INCA , 1 year subscription	ISW_VHW_LIC-US	F-00K-112-886	INCA_VECTOR_HW
Floating license for Vector HW Support for INCA , 1 year subscription	ISW_VHW_LIC-CS	F-00K-112-884	INCA_VECTOR_HW

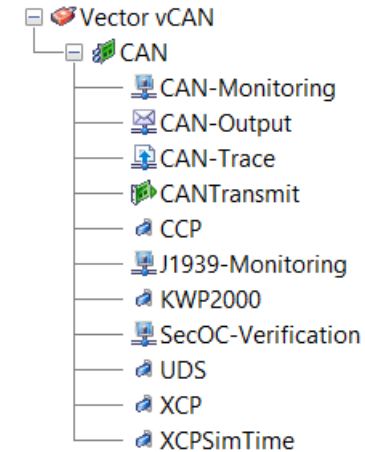
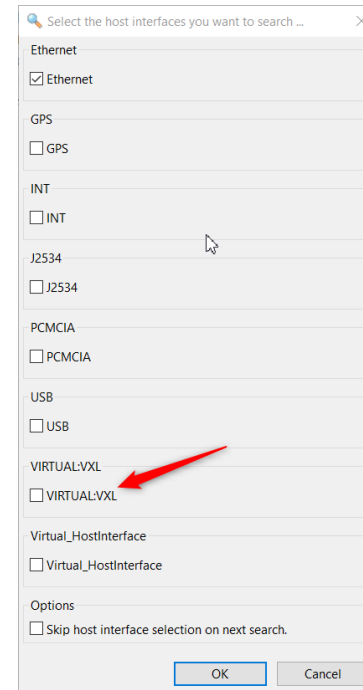

Available with INCA V7.3 SP3

# INCA V7.3 – What's New

## Functionality



### COM-API – Allow INCA FLOW parallel to ASAP3

INCA-FLOW and ASAP3 Server run in parallel with **INCA ASAP3** Option set

The ASAP3 server is configured in INCA INCA-FLOW uses and starts the ASAP3 Server

PC with INCA 7.3 and INCA-FLOW 4.11

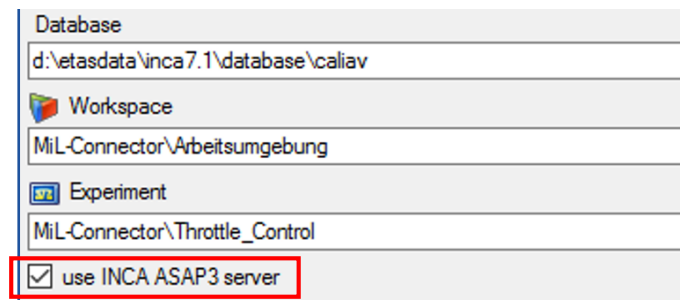
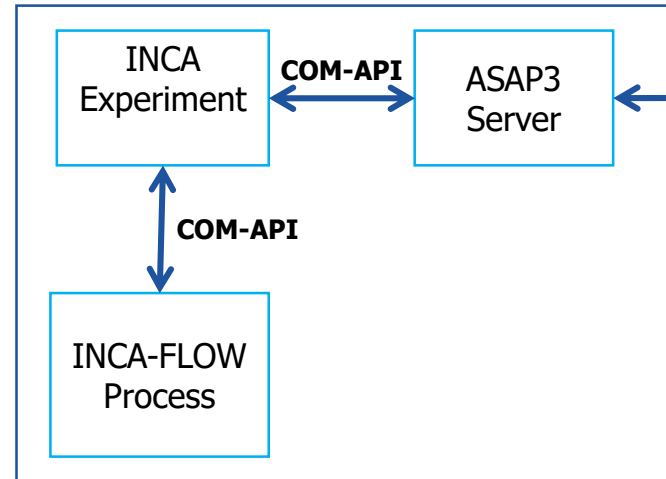

PC with Test Bench Software

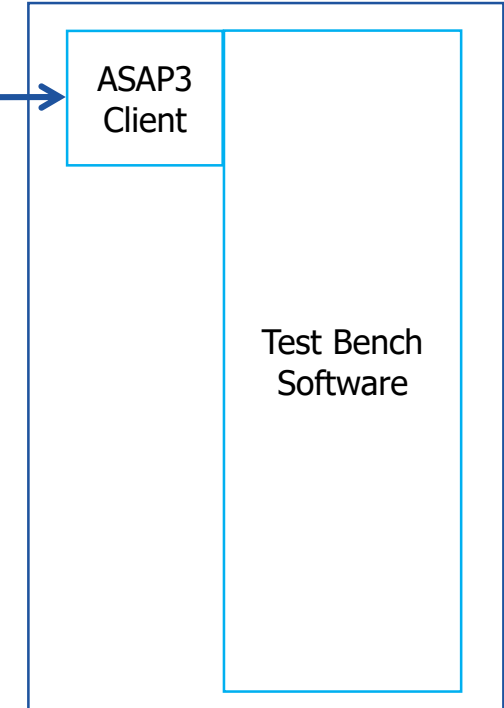

ASAP3 Configuration

Available with INCA V7.3 SP5



## COM-API – New Methods to control the Default Recorder

The new API methods support the date/time, auto increment variables in the recording file name template

- `string IncaOnlineExperiment.GetRecordingFileNameTemplate()`
- `bool IncaOnlineExperiment.SetRecordingFileNameTemplate(string fileNameTemplate)`

The new API methods allow saving the recording files

- ... with the name generated from the file name template
  - `bool Experiment.StopRecordingAndSave()`
  - `bool OnlineExperiment.StopMeasurementAndSave()`
- ... with the specified name (the file name template stays unchanged):
  - `bool Experiment.StopRecordingAndSaveAs(string filePathAndName)`
  - `bool OnlineExperiment.StopMeasurementAndSaveAs(string filePathAndName)`

[Available with INCA V7.3 SP7](#)

# INCA V7.3 – What's New

## Functionality



### Store the Database Tree view for each Database

- INCA saves the view state per database
- INCA saves:
  1. expand/collapse state of the database objects
  2. selection of the database objects
  3. which database object is on top
  4. the scrollbar positions
  5. the split bar positions

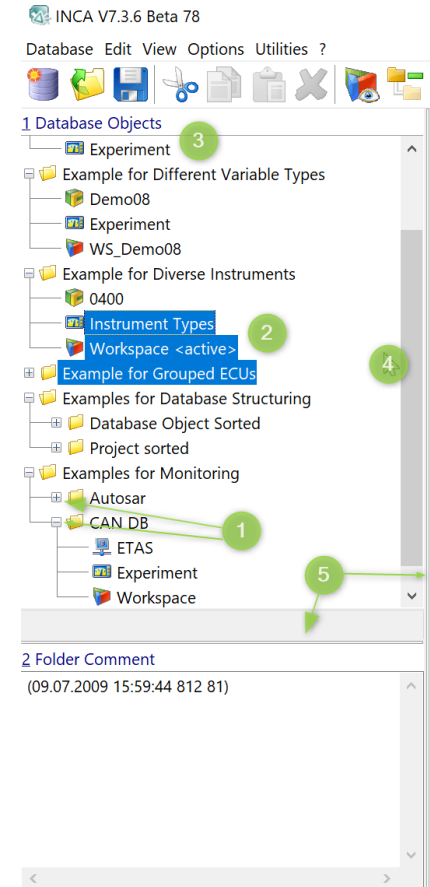

Available with INCA V7.3 SP6

# INCA V7.3 – What's New

## Overview

### 1. Product information (Use cases, Sample applications, Customer value)

- Performance
- Functionality
- Standards
- **Usability**
- HW support
- Add-ons

### 2. INCA Product Family

### 3. Phase out information

### 4. General Notes



# INCA V7.3 – What's New

## Functionality



## INCA – Switching UI Language within INCA

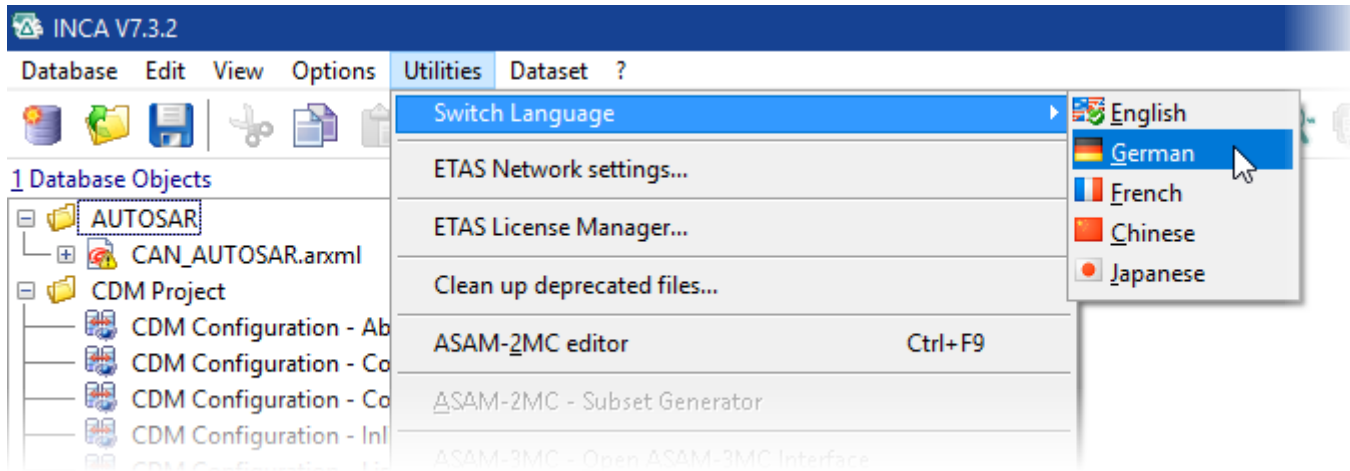

Change is taken into account after re-start of INCA

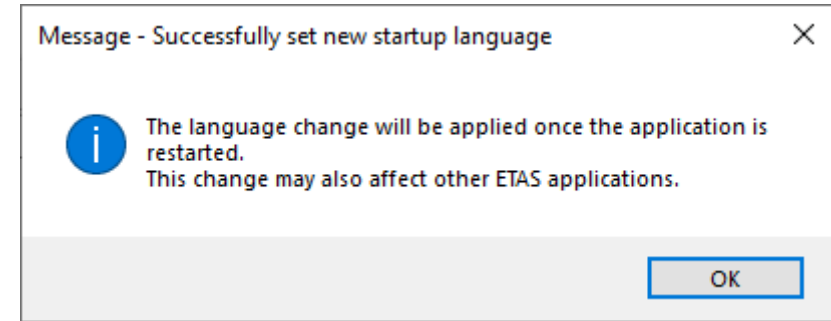

Available with INCA V7.3 SP2

# INCA V7.3 – What's New

## Overview

### 1. Product information (Use cases, Sample applications, Customer value)

- Performance
- Functionality
- Standards
- Usability
- **HW support**
- Add-ons

### 2. INCA Product Family

### 3. Phase out information

### 4. General Notes





# INCA V7.3 – What's New

## Hardware Support



### VN5640 – Support for Automotive Ethernet & BR-XETK

- 2 x CAN(-FD) ports
- 4 x GE ports
- 12 x AE ports (6 x AE + 6 x GAE) or (12 x AE)
- Support of different TAP configuration
- Enable bit (F-00K-112-086)
- Support of Ethernet Monitoring and SOME/IP Monitoring
- Support of UDP
- Support of IPv4 and IPv6 (without header extension)
  
- Some usability restrictions due to missing functionality in the Vector XL API
- New driver "Network-Base-Mode" not yet supported

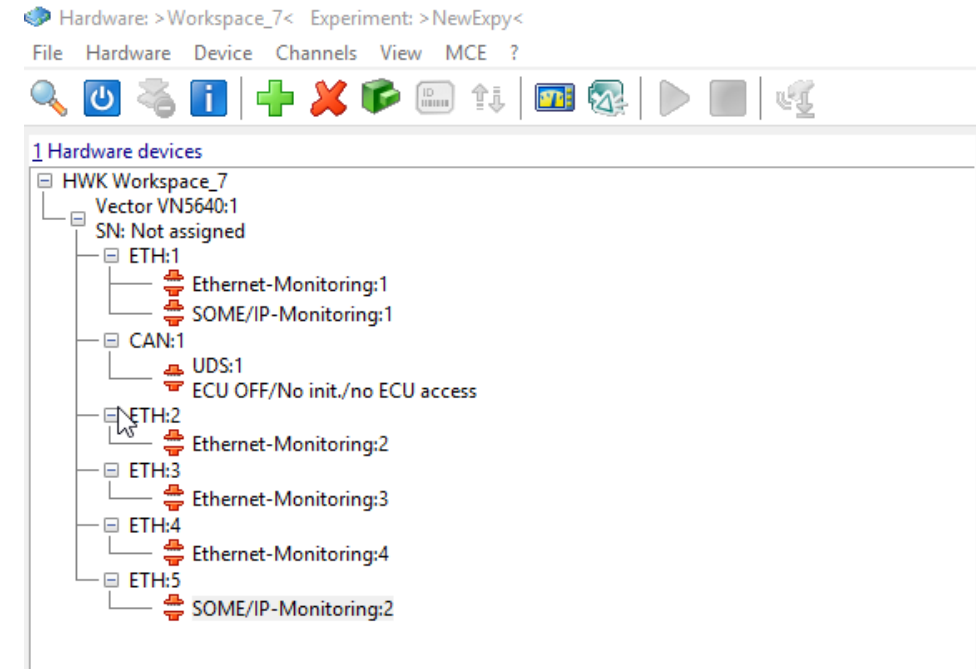

# INCA V7.3 – What's New

## Hardware Support



### Vector VX113x Integration

- VX1132 – CAN Interfaces
- VX1135 – CAN/CAN-FD and FLX Interfaces
- ETH Interface behaves like a switch
- No POD integration
- Not supported by ES820
- INCA\_VECTOR\_HW subscription license required to use VX113x modules in INCA

Description	License	F-Number	Feature
Machine-named license for Vector HW Support for INCA , 1 year subscription	ISW_VHW_LIC-MS	F-00K-112-885	INCA_VECTOR_HW
User-named license for Vector HW Support for INCA , 1 year subscription	ISW_VHW_LIC-US	F-00K-112-886	INCA_VECTOR_HW
Floating license for Vector HW Support for INCA , 1 year subscription	ISW_VHW_LIC-CS	F-00K-112-884	INCA_VECTOR_HW

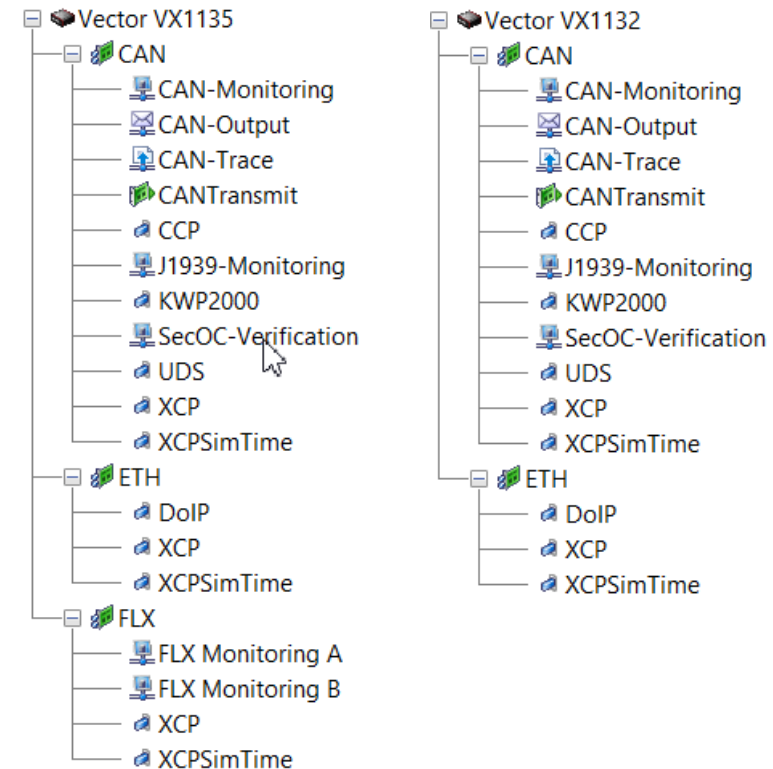

**Note:** [New Vector hardware needs now a license instead of Enable Bit](#)

Available with INCA V7.3 SP3

# INCA V7.3 – What's New

## Hardware Support



### Support of ETH host port to connect Vector HW to INCA PC

- Host port type (USB / Ethernet) will be updated automatically by search result
- Manually configuration in the hardware configuration dialog <sup>1)</sup>
- Supported Vector devices:<sup>2)</sup>
  - VN5620
  - VN5640
  - VN891x

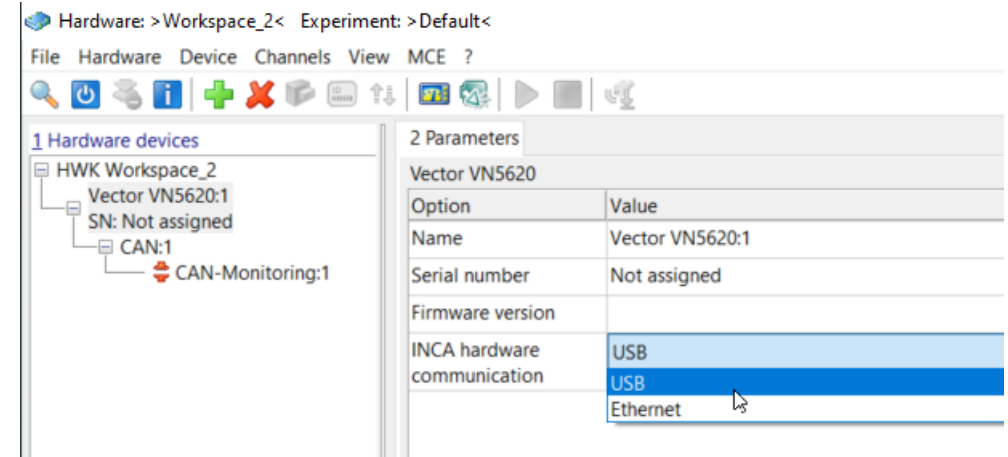

<sup>1)</sup> Ethernet host port configuration has to be setup in Vector configuration tool

<sup>2)</sup> VN5610 not yet supported for ETH host port

# INCA V7.3 – What's New

## Hardware Support



### Make CAN Controller configurable active/passive for CAN/CAN-FD Monitoring/trace

- Configurable bus participation mode (Acknowledge) supported.
- Supported for ETAS and Vector Devices.
- Supported for CAN and CAN-FD
- In the past the CAN controller was always active in INCA.
- The default for the parameter is active.
- In passive mode no frame can be send anymore.
- Protocols like XCP will fail with this parameter set to passive.
- This parameter allows to monitor signals without impacting the other bus communication.

2 Parameters	
CAN	
Option	Value
Name	CAN:1
Port number	CAN1
CAN Master	User defined
Transceiver type	high speed
Transmission rate [Baud]	500000
Sample point	70
BTL cycles	10
SJW	2
Sync edge	SINGLE
ISO15765 TX Notification	estimated
Bus participation mode	Active 
Self reception	Off

Available with INCA V7.3 SP5

# INCA V7.3 – What's New

## Hardware Support



### Make CAN Controller Self-Reception configurable for CAN/CAN-FD Monitoring/trace

- Configurable self reception mode supported.
- Supported for ETAS and Vector Devices.
- Supported for CAN and CAN-FD
- In the past this parameter was only set on internally for special use cases.
- The default for the parameter is "Off".
- In "On" mode it is now possible to monitor or to trace messages which are send by INCA itself on the identical CAN port.
- Activating the parameter makes only sense if monitoring or trace was configured to this CAN port.

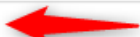
CAN	
Option	Value
Name	CAN:1
Port number	CAN1
CAN Master	User defined
Transceiver type	high speed
Transmission rate [Baud]	500000
Sample point	70
BTL cycles	10
SJW	2
Sync edge	SINGLE
ISO15765 TX Notification	estimated
Bus participation mode	Active
Self reception	Off 

Available with INCA V7.3 SP5

# INCA V7.3 – What's New

## Hardware Support



### ES160, ES162 and ES165 Integration in INCA - AE Media Converter

- Configuration of speed 100/1000/Auto
- Configuration of link Master/Slave/Auto
- Supports alias name
- Supports replace system
- Support serial number mapping
- Supports EthernetPortConfiguration device  
This device is a dummy device to be able to configure the Ethernet port without configuring a XCP or DoIP device if Auto-configuration is not sufficient for the use case.

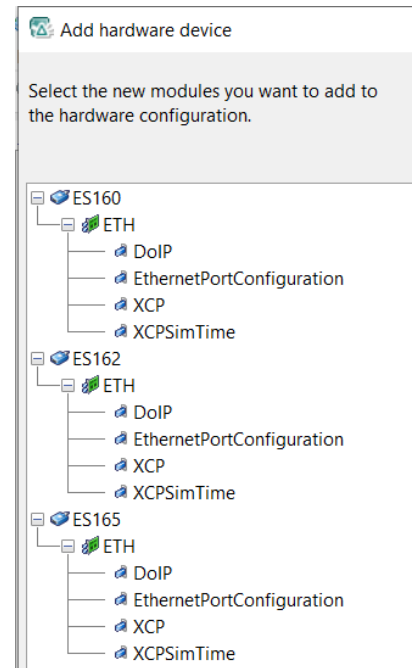

ES160:  
Rj45 connector  
External power



ES162:  
Lemo **GE** connector with  
integrated power



ES165:  
Lemo **FE** connector with  
integrated power

Available with INCA V7.3 SP2

# INCA V7.3 – What's New



## Hardware Support

### Support of more than 4x ES523 /ES59x devices

#### Maximum number of configurable modules in one hardware configuration

- 20x ES16x
- 8x ES511, ES512, ES523, ES581.4, ES582, ES583, ES584, ES592, ES593-D, ES595, ES8xx-Stack
- 4x ES910.3, VN1610, VN1611, VN1630, VN1640, VN7600, VN7610, VN8910
- 2x VX1132, VX1135

#### Note

A combination of too many interfaces may lead to an overload of the overall bandwidth of the system

[Available with INCA V7.3 SP3](#)

# INCA V7.3 – What's New

## Hardware Support



### ES850 – Measurement Module for A/D and Thermo Channels

The ES850 extends the ES800 stack with measurement capabilities for 16 A/D and 16 Thermo signals with configurable sample rates of 10 and 100kSamples/s for the A/D channels.



#### Performance

- **Stackable** feature of the ES8xx device family
- **32 Channels** (16 A/D + 16 Thermo) per module
- **100kSamples/s** for the A/D channels
- **1 Gbit/s** data transmission to HOST



#### Standard

- **XCP 1.4 standard support**
  - Support of "Package MODE". It reduces the BUS load by packing the signal values conform to XCP standard
  - Generation of ASAP2 (A2L) description file



#### Accuracy

- Precise **Time Synchronization** through standard IEEE1588/PTP
- Measurement values synchronized with other signals in the stack
- Correlation and Correction of the sampling time points with the impulse response time
- **Higher accuracy** of 500Hz for the AC voltage measurement



#### Ease of Use

- Device can easily be identified using Config Tool in combination of LED status on the front blend of device
- **Standalone Configuration Tool** + Standalone capability through **Advanced analog and digital filters**

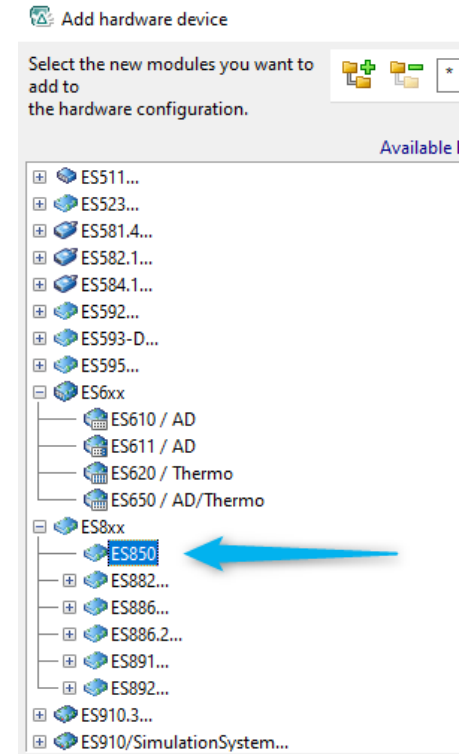

Available with INCA V7.3 SP7



# INCA V7.3 – What's New

## Hardware Support

### Import ES6xx module parameters from Excel (CSV)

- Import / Export device parameters
- Import / Export channel parameters

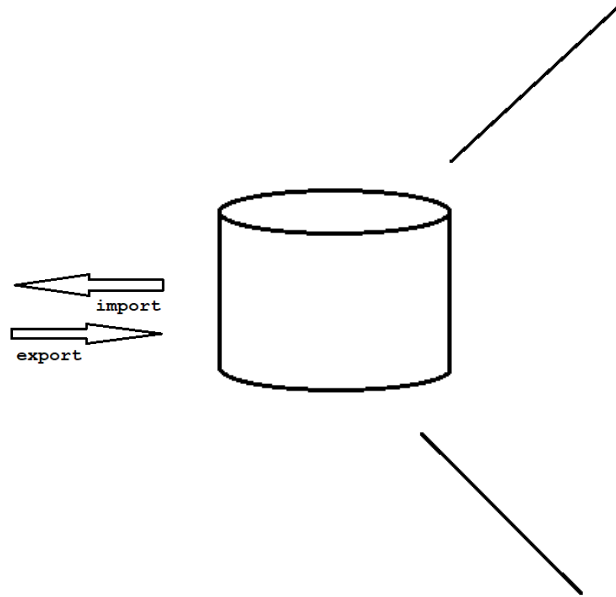
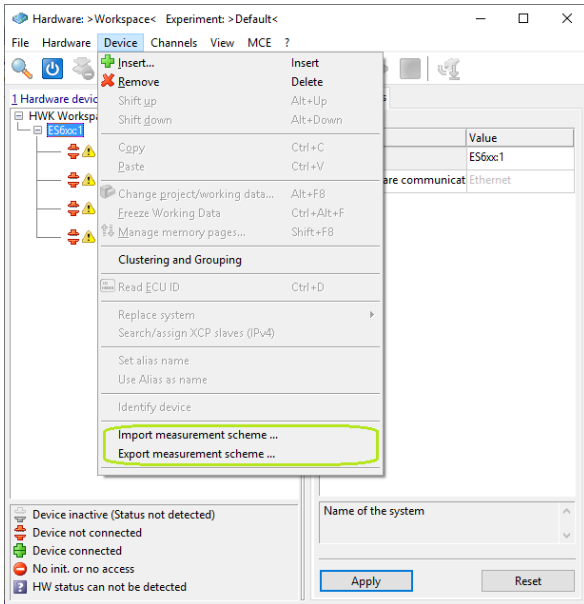

```
Version = 1.0 FieldSeparator = ; FloatSeparator = , Declaration information

#DeviceType;#MItemName;#etasSerialNumber;#MItemAliasName; Device header Device Info 1
ES610;ES610 / AD;1;;;

#Index;#Name;#Unit;#Rate;#FilterFrequencyMode;#FilterFrequency;#PhysMin; ... Channel table
1;AC1_AD2;V;10;predefined;auto;0.0;10.0;0.0;off;;;0.0;10.0;
2;AC1_AD2;V;10;predefined;auto;0.0;10.0;0.0;off;;;0.0;10.0;
3;AC1_AD3;V;10;predefined;auto;0.0;10.0;0.0;off;;;0.0;10.0;
:

#DeviceType;#MItemName;#etasSerialNumber;#MItemAliasName; Device header Device Info 2
ES611;ES611 / AD;1;;;

#Index;#Name;#Unit;#Rate;#FilterFrequencyMode;#FilterFrequency;#PhysMin; ... Channel table
1;AC1_AD3;V;10;predefined;auto;0.0;60.0;0.0;off;;;0.0;60.0;on;
2;AC1_AD2;V;10;predefined;auto;0.0;60.0;0.0;off;;;0.0;60.0;on;
3;AC1_AD3;V;10;predefined;auto;0.0;60.0;0.0;off;;;0.0;60.0;on;
:

#DeviceType;#MItemName;#etasSerialNumber;#MItemAliasName; Device header Device Info 3
ES620;ES620 / Thermo;1;;;

#Index;#Name;#Unit;#Rate;#SensorType;#SensorOffsetMode;#PhysReferenceValue; ... Channel table
1;TCL_Th3;C;1000;K;off;;;0.0;10.0;
2;TCL_Th2;C;1000;K;off;;;0.0;10.0;
3;TCL_Th3;C;1000;K;off;;;0.0;10.0;
4;TCL_Th4;C;1000;K;off;;;0.0;10.0;
:

#DeviceType;#MItemName;#etasSerialNumber;#MItemAliasName; Device header Device Info 4
ES608;ES608 / AD;Thermo;1;;;

#Index;#Name;#Unit;#Rate;#FilterFrequencyMode;#FilterFrequency;#PhysMin; ... Channel table
1;DCL_AD1;V;10;predefined;auto;0.0;10.0;0.0;off;;;0.0;10.0;
2;DCL_AD2;V;10;predefined;auto;0.0;10.0;0.0;off;;;0.0;10.0;
3;DCL_AD3;V;10;predefined;auto;0.0;10.0;0.0;off;;;0.0;10.0;
:
9;DCL_Th1;C;1000;K;off;;;0.0;10.0;K;
10;DCL_Th2;C;1000;K;off;;;0.0;10.0;K;
11;DCL_Th3;C;1000;K;off;;;0.0;10.0;K;
:
```

Available with INCA V7.3 SP4



# INCA V7.3 – What's New



## Hardware Support

### Reconfiguration of XETK/FETK during Hardware Initialization

During hardware initialization a reconfiguration of the connected XETK/FETK might be necessary. This also might require an ECU reset.

- In previous INCA versions the handling of two consecutive dialogs was necessary

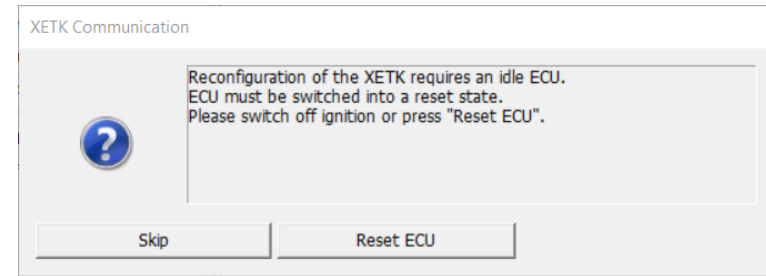
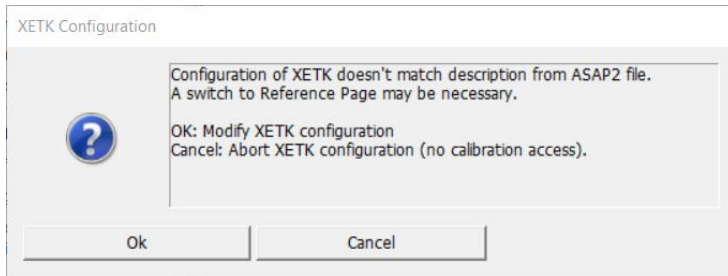

- INCA displays only one dialog in that case.

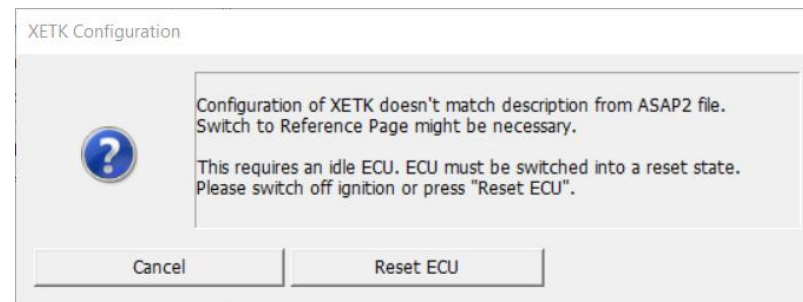

Available with INCA V7.3 SP4

# INCA V7.3 – What's New

## Hardware Support

### VN5620 Support

- 2 x CAN/CAN\_FD ports
- Subscription SW license required
- Enable bit not supported for this device
- Ethernet port support planned for INCA V7.3.6
- Ethernet and USB Host port supported.

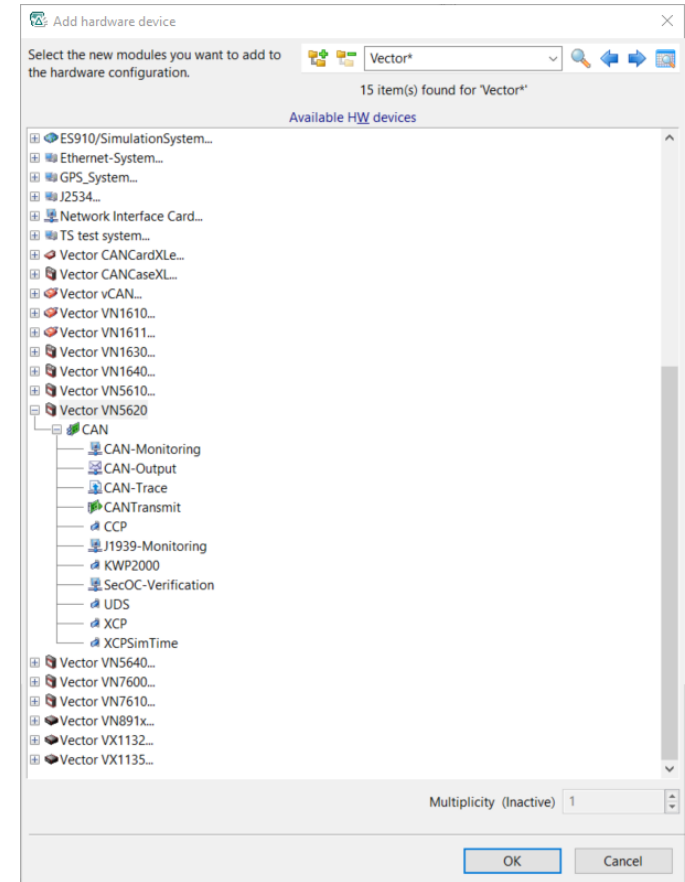

Available with INCA V7.3 SP5

# INCA V7.3 – What's New

## Hardware Support

### VN7640 Support

- Host interface to PC: Ethernet or USB
- Supported Interfaces: CAN, LIN and FLX
- Maximum number of devices: 4
- Licensing: Only SW Licensing, no Etas Enable Bit available

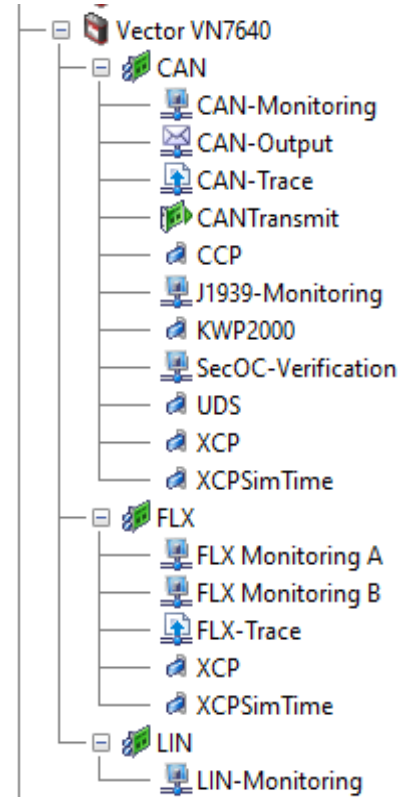

Available with INCA V7.3 SP7

# INCA V7.3 – What's New

## Hardware Support

### VN891x support

- Existing VN8910 system renamed to VN891x.
- Support of VN8910/VN8911 and VN8914 chassis as VN891x system.
- Enable bit support for VN891x until Q1/2022 (USB).
- Subscription SW license supported for VN891x (USB and ETH).
- Ethernet and USB Host port supported.
- Supporting different piggy's VN89xx.

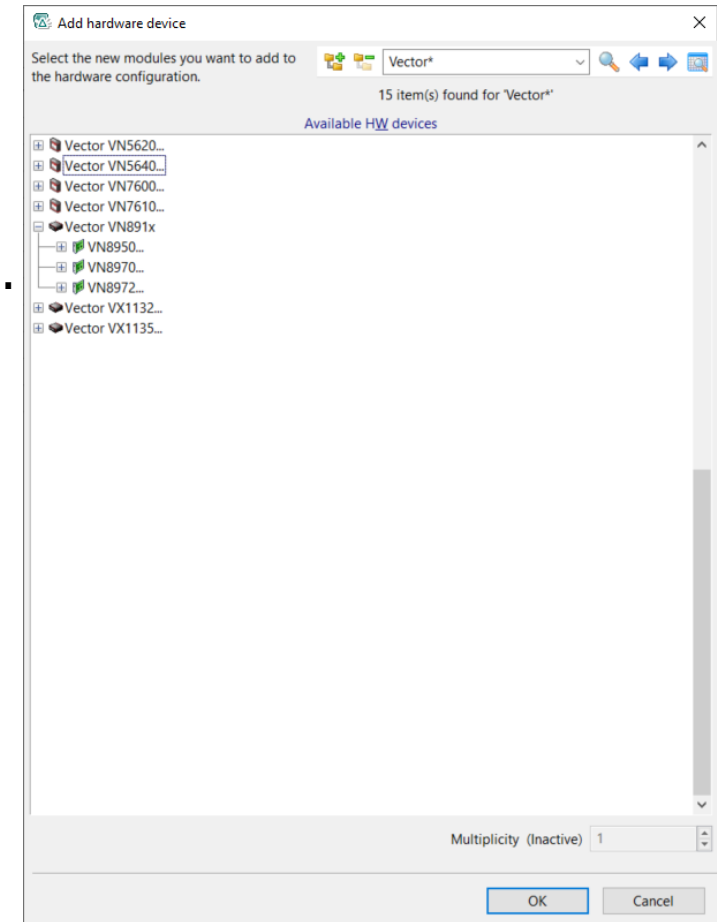

Available with INCA V7.3 SP5

# INCA V7.3 – What's New

## Hardware Support

### VN8972 support

- VN8972 is a piggy for the VN891x chassis system.
- Supports up to 8 CAN/CAN-FD ports.
- Supports up to 2 FLX ports.
- Supports up to 4 LIN ports.

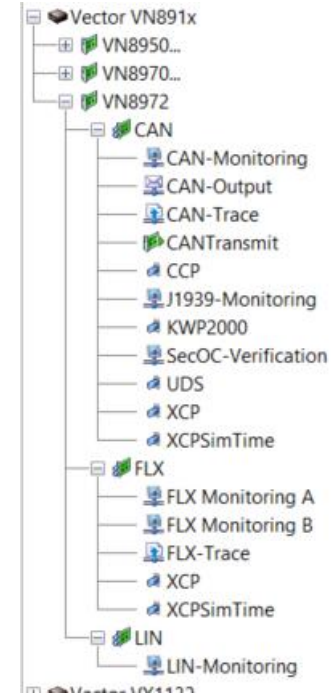

Available with INCA V7.3 SP5



# INCA V7.3 – What's New

## Overview

### 1. Product information (Use cases, Sample applications, Customer value)

- Performance
- Functionality
- Standards
- Usability
- HW support
- **Add-ons**

### 2. INCA Product Family

### 3. Phase out information

### 4. General Notes



# INCA V7.3 – What's New

## Add-ons

### **MATLAB – Support of MATLAB 2020A**

- INCA-SIP & INCA-MIP

### **Improvement of referenced models functionality in INCA-SIP**

- Users can choose whether they want to include all referenced models at once or a specific subset

### **User interface improvements for INCA-SIP**

- New arrangement of UI elements into meaningful groups

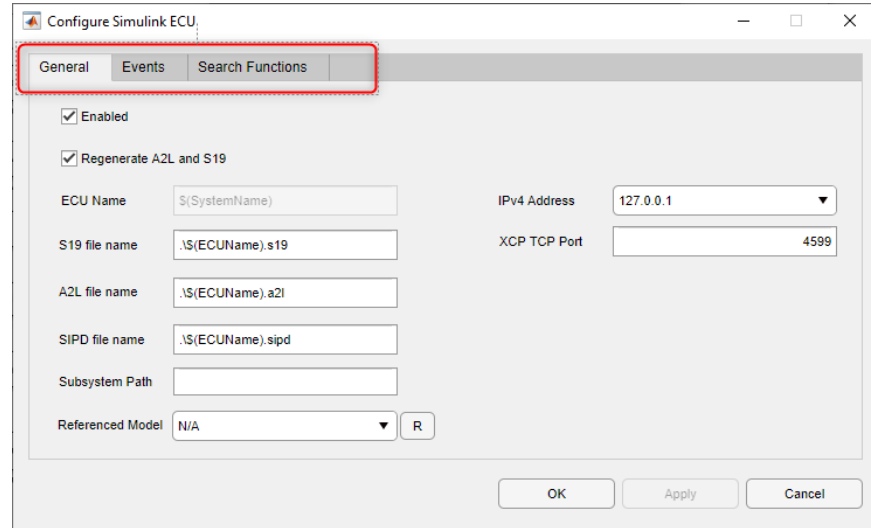

Available with INCA V7.3 SP1



# INCA V7.3 – What's New

## Add-ons



### **MATLAB – Support of MATLAB 2020B**

- INCA-MIP & INCA-SIP supports the MATLAB version 2020B

Available with INCA V7.3 SP3

# INCA V7.3 – What's New

## Add-ons



### **MATLAB – Support of MATLAB 2021B**

- INCA-MIP & INCA-SIP supports the MATLAB version 2021B

Available with INCA V7.3 SP7

# INCA V7.3 – What's New

## Add-ons



### **INCA-SIP – Support MDF-Files as Input Stimuli in Simulink®**

- The user can define an MDF-File as signal stimulus for a Simulink® Model.
- Thus, a simulation can be run using pre-recorded measurement files as input

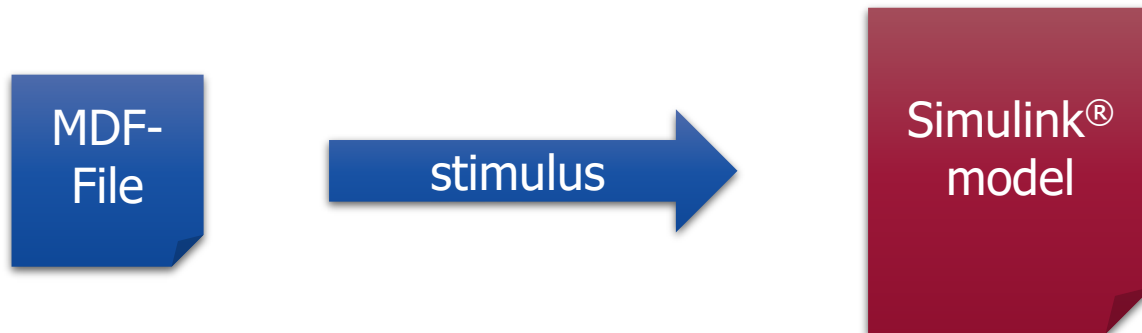

# INCA V7.3 – What's New

## Add-ons



### INCA-SIP – MDF-Write functionality

With the MDF-Write functionality INCA-SIP can write MDF-files directly out of Simulink<sup>®</sup> using the 'signal logging' feature.

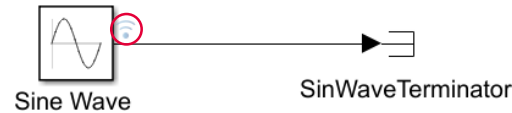

The 'signal logging' data generated by the Simulink<sup>®</sup> model can be written/exported as an MDF-file and afterwards be analysed in MDA.

Available with INCA V7.3 SP7

# INCA V7.3 – What's New

## Add-ons



## **INCA-SIP – Support Additional Standard Simulink® Blocks**

- New Search function has been added to support the Simulink® Block 'Manual Switch'
- Improvements to mask parameter now allow INCA-SIP to read and write values to mask parameters of type 'promote'. This automatically added the support of more Simulink® blocks, for example:
  - PID Controller
  - PID Controller (2DOF)
  - Discrete PID Controller
  - Discrete PID Controller (2DOF)
  - Bitwise Operator

# INCA V7.3 – What's New

## Add-ons



### INCA-SIP – Basic Support of FMU-Blocks

- Masked parameters of FMU blocks in Simulink® models can now be measured and calibrated.
- Due to limitations of the current FMI specification, all parameters are modelled as scalar calibrations in INCA. Multi-dimensional calibration arrays/maps are not supported.
- This feature is supported from MATLAB® 2017B onwards.

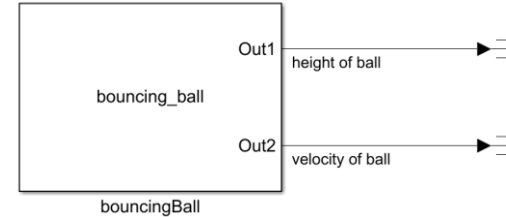

Block Parameters: bouncingBall  
bouncing\_ball [Model Exchange, v2.0]  
FMU Block  
Simulation of a Bouncing Ball. This is a simulation of a hybrid dynamic system.  
Open FMU Documentation File

Parameters Simulation Input Bus Output Bus

Filter by name or description

Parameter	Value	Unit	Description
Param1	9.81		Param1: Param1: a...
Param2	0.7		Param2: Param2: c...

OK Cancel Help Apply

Calibration Window [1]

bouncingBall.Param1	9.81000	
bouncingBall.Param2	1.70000	

Available with INCA V7.3 SP4

# INCA V7.3 – What's New

## Add-ons



## MCE – ASAP3 with iLinkRT V1.3 / V2.0

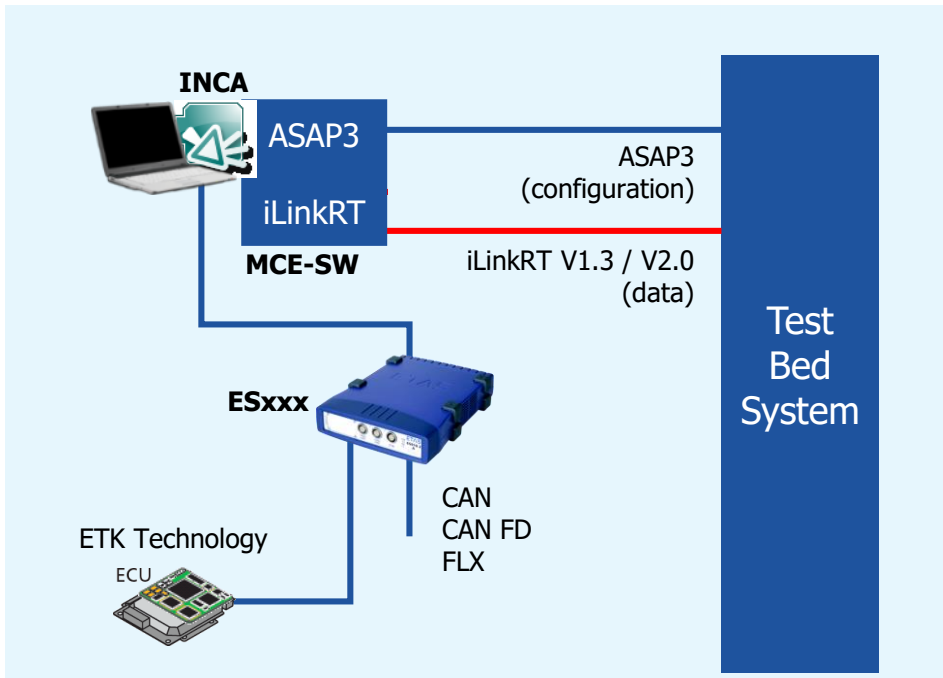

### New

- PC based iLinkRT solution
- Beside ECU interfaces additionally measurement and monitoring devices are supported

### Performance attributes and key features

- Down to 100 millisecond latency for measurement of 100 ECU measurement variables (a 2 Byte) in running experiment
- Down to 60 millisecond calibration performance for single map (16x16, 512 Bytes) flat calibration
- Supported ECU-Interfaces: CCP, XCP, ETK, XETK, FETK, Measure Modules

### Products and services required

- INCA V7.3, INCA MCE

### Major prerequisites

- Test bed system with support of ASAP3 (for system configuration) and iLinkRT V1.3 / V2.0 (for ECU measuring and parameter exchange)

[Available with INCA V7.3 SP2](#)

# INCA V7.3 – What's New



## Add-ons

### iLinkRT COM Master - FLOAT64 Support

iLinkRT COM Master supports FLOAT64

Needed for the PC based iLinkRT V2.0 Solution

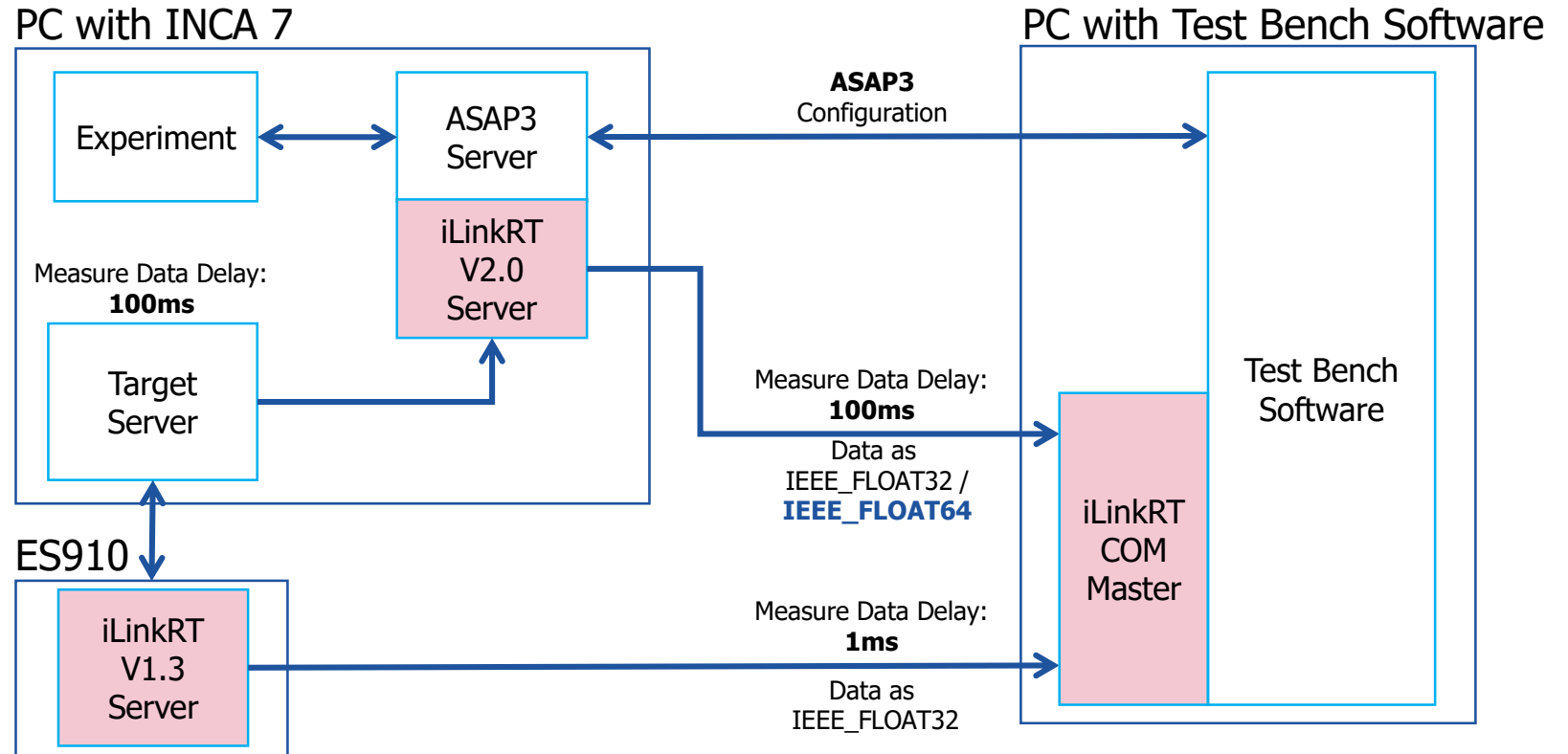

Available with INCA V7.3 SP5



# INCA V7.3 – What's New

## Add-ons



## iLinkRT V3 – Multi Client Test Bench Support

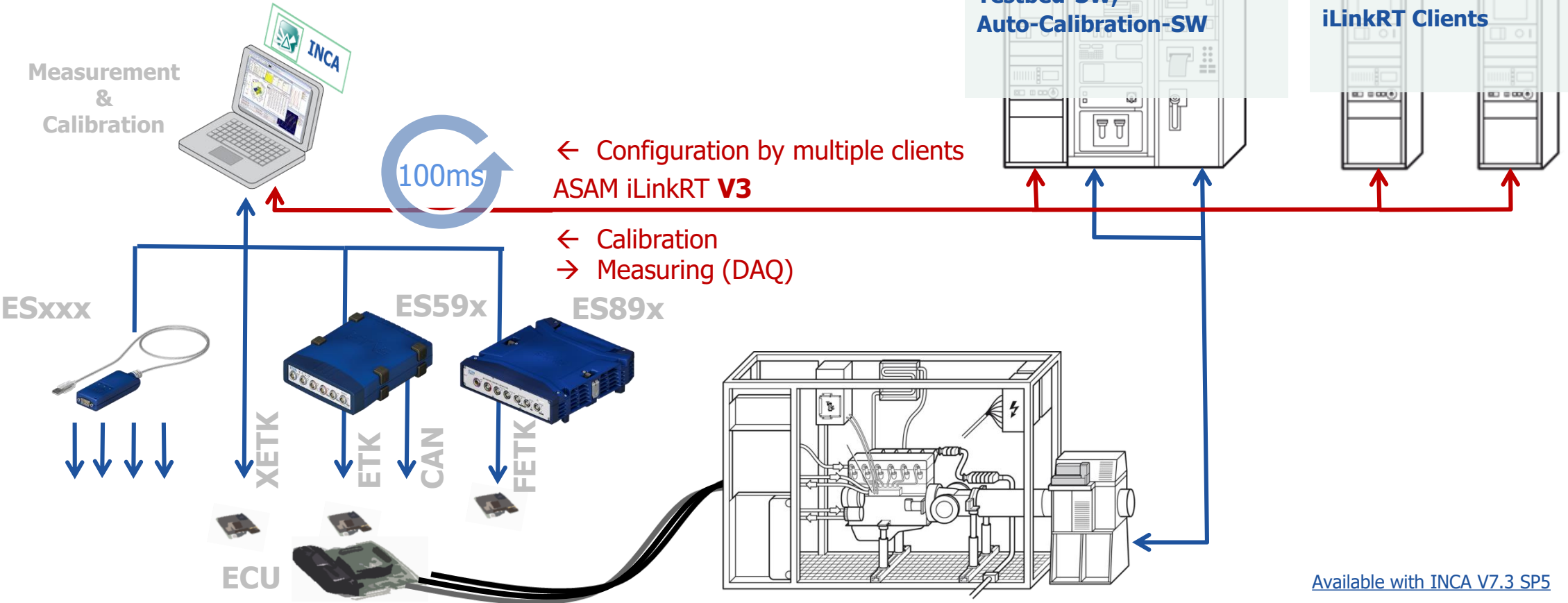

Available with INCA V7.3 SP5

# INCA V7.3 – What's New

## Functionality



## MCE – iLinkRT V3: Change Workspace / Hex File

### RT\_GET\_AVAILABLE\_DEVICE\_SETS

- Allows to request the Workspaces available
- Search is extendable

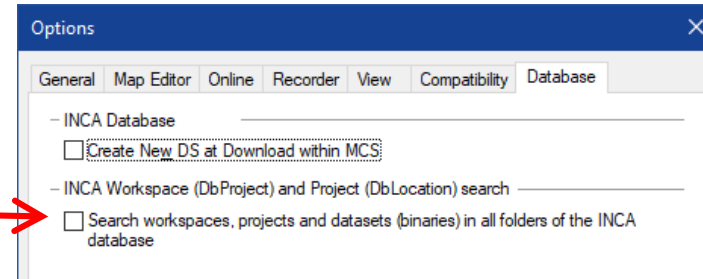

### RT\_SELECT\_DEVICE\_SET

- Allows to open a different Workspace
  - The currently open workspace is closed
  - A different INCA workspace is opened
- Allows to close a Workspace
  - INCA Options that require a closed Workspace can be set

### RT\_CHANGE\_HEX\_FILE

- Allows to replace the working page

Available with INCA V7.3 SP6

# INCA V7.3 – What's New

## Overview

### 1. Product information (Use cases, Sample applications, Customer value)

- Performance
- Functionality
- Standards
- Usability
- HW support
- Add-ons

### 2. INCA Product Family

### 3. Phase out information

### 4. General Notes



# INCA V7.3 – What's New

## INCA Product Family



### ProF Flashing with Lua scripts

- INCA supports as ProF configurations Lua script files additionally to PRM files
  - Lua is a proven, robust, fast and well documented programming language used in many applications
  - Lua is powerful, but simple and easy to learn
  - Lua supports modules, functions, types, string manipulation, mathematical functions, etc.
- All known ProF flash commands are also supported with Lua
- All protocols supported by ProF are also supported with Lua, e.g. CCP, XCP, UDS, KWP, ETK
- Same INCA usability for Lua as for PRM ProF configurations
- Updated ProF documentation available at the ETAS MCD support

#### Note

INCA still supports existing ProF scripts

[Available with INCA V7.3 SP3](#)

# INCA V7.3 – What's New

## INCA Product Family



### IP-Manager option to activate/deactivate automatic IP re-assignment

The IP-Manager supports now an additional automatic mode which allows the user an easier HW IP re-assignment.

With this option the IP-Manager automatically allocates all found HW which are already configured to another network to the current network. This helps if the user is going from car to car and colleagues are working with different IP settings in the same cars.

Added new column with network connection name.

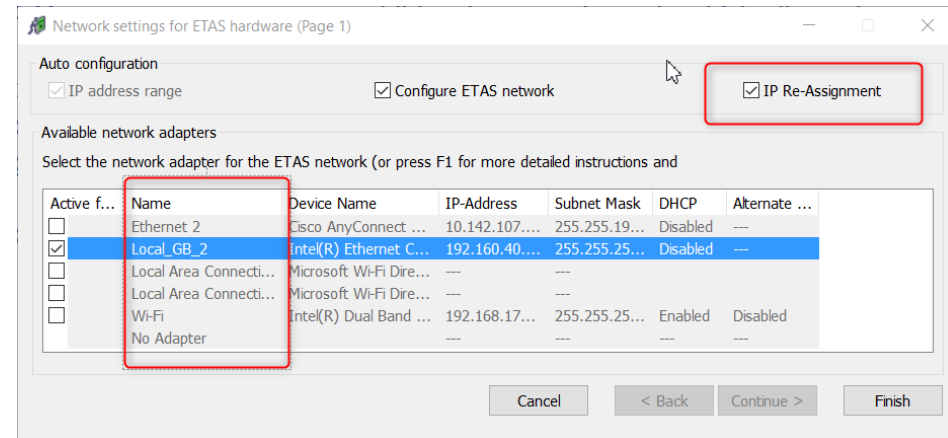

Available with INCA V7.3 SP1

# INCA V7.3 – What's New

## INCA Product Family



### INCA – Support of FlexNet Embedded licenses for machine based licenses

ETAS introduces a new license technology called FlexNet Embedded. In a first step new machine based licenses will use this technology. Existing licenses can still be used during a migration phase.

FlexNet embedded offers modern, future-proof technology. New machine based licenses can be activated online using the ETAS license manager.

Offline activation is also possible for those PCs without internet connection

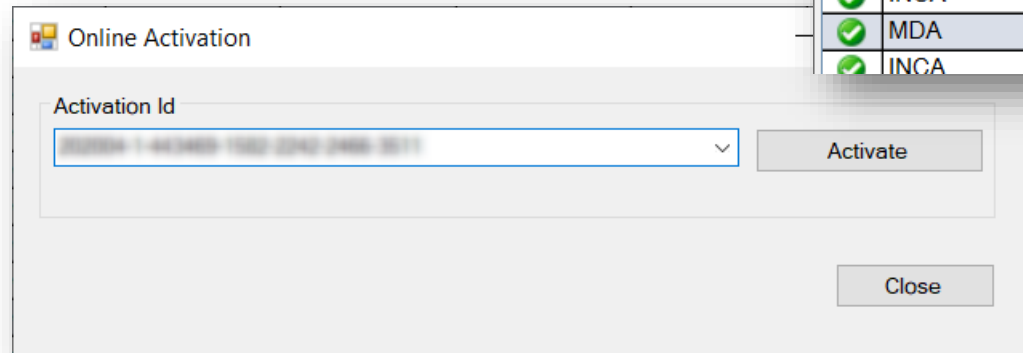
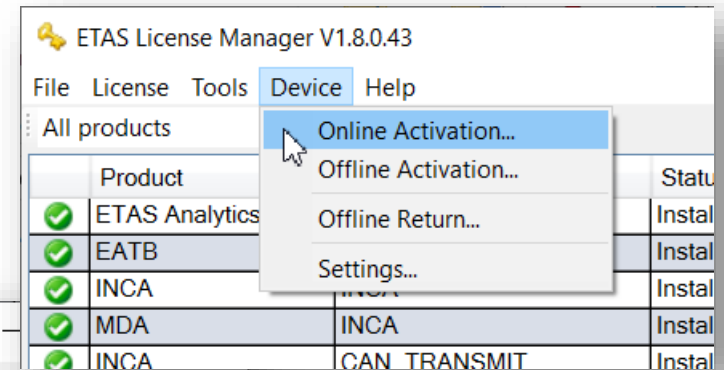

Available with INCA V7.3 SP2

# INCA V7.3 – What's New

## INCA Product Family



## xETK Config Tool – Logging/Error Window

The XCT provides two windows for logging:

- The Application Log Window
  - Text window based
  - Editable by the user
  - Cut, copy, clear functionality
- The Configuration Errors and Warnings Window
  - Displays active errors and warnings regarding the device configuration
  - Resolved errors and warnings disappear from the window
  - Filtering functionality

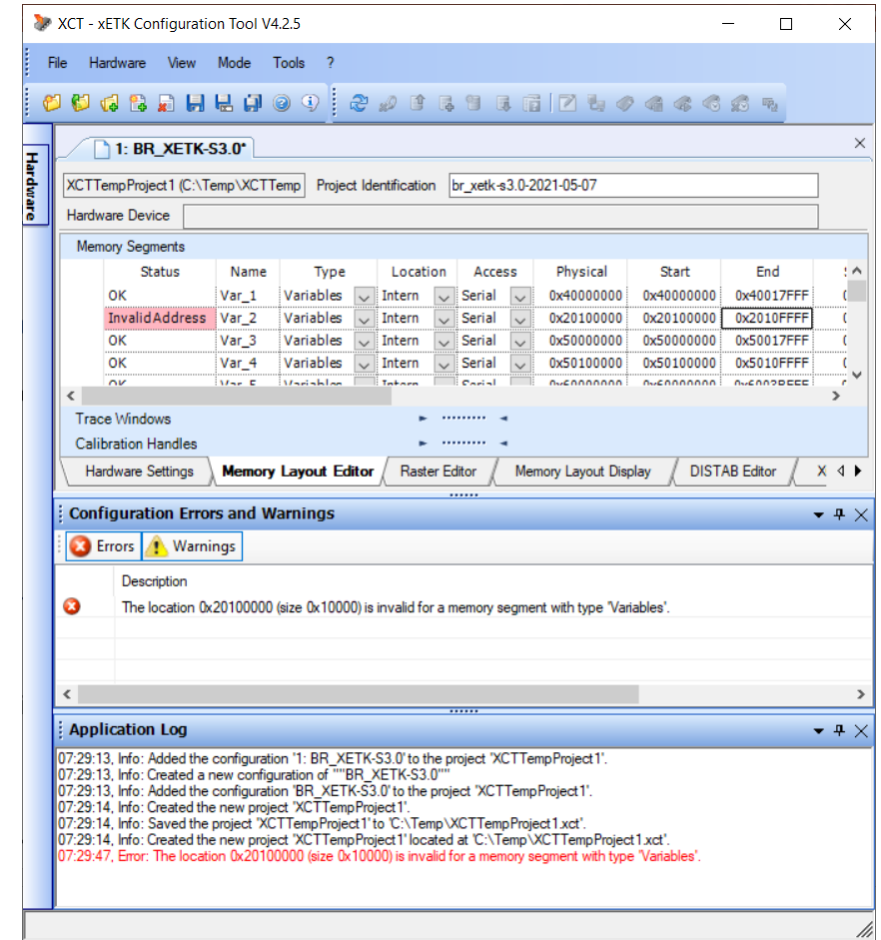

Available with INCA V7.3 SP5

# INCA V7.3 – What's New

## INCA Product Family



### **INCA – Migration of machine based FNP licenses to FNE licenses**

ETAS switches from FlexNet Publisher (FNP) to FlexNet Embedded (FNE) license types.

INCA 7.3 accepts for "PC based" licenses FNE license types in parallel to the existing FNP licenses.

To use the INCA "PC based" licenses also in the future the available FNP licenses can be exchanged by FNE licenses. This can be done online in the INCA license portal.

**The possibility to exchange licenses starts now!**

For details please see [Time Line](#) and further info in [ETAS License Management FAQ](#)

Available with INCA V7.3 SP4



# INCA V7.3 – What's New

## Functionality



### ETAS License Manager – Migration wizard for new license technology

ETAS switches from FlexNet Publisher (FNP) to FlexNet Embedded (FNE) license technology.

The first step was done by introducing the new technology for **machine based** licenses:

- INCA 7.3 accepts both FNE licenses and FNP licenses.
- INCA 7.4 will accept FNE licenses only (Release in 03/2022)

To assist you with this, ETAS License Manager offers a wizard which migrates your machine based FNP licenses to FNE licenses.

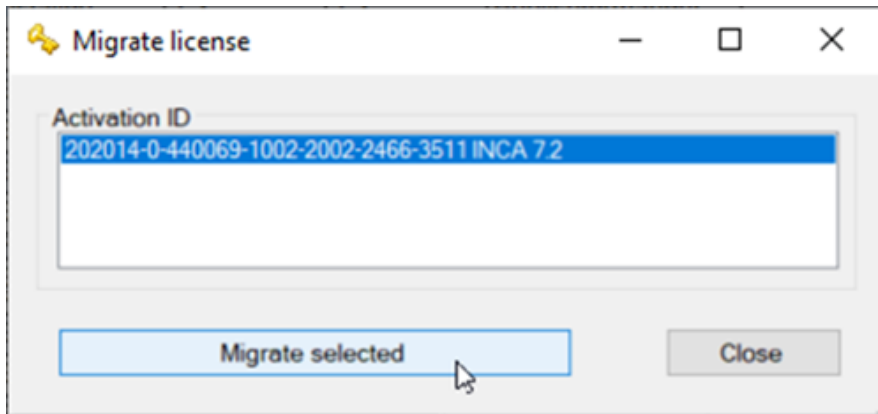

Note:

- ETAS License Manager > 1.8.2 and a valid service contract are required
- New bought machine based INCA licenses are automatically based on FlexNet Embedded.
- User based or Floating licenses are still based on FlexNet Publisher. Further information on introducing FNE for these will follow.

For details please see [Time Line](#) and further info in [ETAS License Management FAQ](#)

Available with INCA V7.3 SP6

# INCA V7.3 – What's New

## INCA Product Family



## Support of Windows Server as OS

INCA<sup>\*)</sup>, MDA and HSP are now installable on Windows Server 2016 / 2019

### Usage

- Only one INCA instance can be used at a time
- Only one MDA instance can be used at a time
- Only one HSP instance can be used at a time

<sup>\*)</sup>INCA Flow, INCA RDE is not released for Windows Server

[Available with INCA V7.3 SP4](#)

# INCA V7.3 – What's New

## Overview

### 1. Product information (Use cases, Sample applications, Customer value)

- Performance
- Functionality
- Standards
- Usability
- HW support
- Add-ons

### 2. INCA Product Family

### 3. Phase out information

### 4. General Notes



# INCA V7.3 – What's New

## Phase Out Information



## Hardware that is no longer supported by INCA V7.3

Hardware / Modules	Hardware QA6 Dates
ES520	10/2017
Kvaser HW	06/2019
ES690	02/2011
ES590/ES591 (incl. K-Line)	06/2020
SMB/SMB-COM (Connected via RS232)	06/2020
Output COM	Driver for output data via RS232 interface
E-Target: ES1000.3, ES1130, ES1135, VADI, VADI2, VDAI, KID, ASCET-RS	06/2020
VADI Test Device	Test device for ES1000
XCP on USB	No hardware released
ES580 CAN-Link	07/2019
ES581.3	01/2018
OHI_CAN (incl. EtasCan2Boa & EtasCan2Sic)	Driver for OHI, replaced by BOA drivers
ES720 (a workaround via INCA export for INCA V7.2 is possible)	10/2019

# INCA V7.3 – What's New

## Phase Out Information

### Announcement concerning "HW Enable Bits"

- The ETAS enable bits functionality for Supported Vector hardware will be phased out
- QA5 Sales stop is planned for Q1/2022
- QA6 Service stop is planned for Q1/2025

### **For already supported Vector devices and all newly integrated Vector devices INCA supports now a SW license (Machine-Based, User-Based and Floating)!**

All Vector devices with active Enable Bit will be supported by INCA at least till QA6 of the hardware.

- INCA checks for the enable bit first
- If no enable bit is available INCA will check for the SW license

[Available with INCA V7.3 SP3](#)

# INCA V7.3 – What's New

## Overview

### 1. Product information (Use cases, Sample applications, Customer value)

- Performance
- Functionality
- Standards
- Usability
- HW support
- Add-ons

### 2. INCA Product Family

### 3. Phase out information

### 4. General Notes

# INCA V7.3 – What's New

## Overview of Functionality added by Service Packs



### Links to Functionality Description of Service Pack 1

- [DoIP – Measurement and Calibration over UDS on Ethernet](#)
- [Recorder – Add Calibration Info to support Big Data](#)
- [AUTOSAR – End to End communication protection \(E2E\) for SOME/IP](#)
- [AUTOSAR – V4.4 Support](#)
- [XCP V1.4 – Support of Packed DAQ Lists \(DAQ Packed Mode\)](#)
- [Ethernet/SOME IP Monitoring on local network cards](#)
- [Allow more than one CAN-Monitoring device below CAN/CAN-FD node](#)
- [IP-Manager option to activate/deactivate automatic IP re-assignment](#)
- [MATLAB – Support of MATLAB 2020A](#)

# INCA V7.3 – What's New

## Overview of Functionality added by Service Packs



### Links to Functionality Description of Service Pack 2

- [Recorder – Add Calibration Info to support Big Data](#)
- [ES4xx – Import of channel parameters using a csv file](#)
- [INCA – Switching UI Language within INCA](#)
- [XCP – Calibration Method "Autosar Single Pointer Calibration"](#)
- [XCP V1.4 Support of consistency event list for measurements](#)
- [XCP V1.4 Support Efficient DAQ Data Transfer on CAN \(MEASUREMENT\\_SPLIT\\_ALLOWED\)](#)
- [XCP V1.4 Support of Consistency NONE](#)
- [XCP V1.4 DAQ Packed Mode with Predefined DAQ lists](#)
- [ES160, ES162 and ES165 Integration in INCA - AE Media Converter](#)
- [MCE – ASAP3 with iLinkRT V1.3 / V2.0](#)
- [INCA – Support of FlexNet Embedded licenses for machine based licenses](#)



# INCA V7.3 – What's New

## Overview of Functionality added by Service Packs



### Links to Functionality Description of Service Pack 3

- [XCP V1.4 – DATA SIZE in combination with CONSISTENCY EVENT LIST](#)
- [UDS on FlexRay Flashing with AUTOSAR file](#)
- [ProF Flashing with Lua scripts](#)
- [Support of Vector virtual CAN](#)
- [Support of more than 4x ES523 /ES59x devices](#)
- [MATLAB – Support of MATLAB 2020B](#)
- [AUTOSAR – Release 19-11 Support in INCA](#)
- [AUTOSAR – Referenced Autosar files](#)
- [AUTOSAR – Multiple Sub-Description Files](#)
- [AUTOSAR – Multiple Byte elements for I SIGNAL TYPE ARRAY](#)
- [ASAP2 - DISCRETE](#)
- [Clustering of ECUs in the EE](#)
- [Vector VX113x Integration](#)
- [Announcement concerning "HW Enable Bits"](#)
- [Multi-Dimensional Measurements - ASAP2 LAYOUT](#)

# INCA V7.3 – What's New

## Overview of Functionality added by Service Packs



### Links to Functionality Description of Service Pack 4

- [AUTOSAR - Support of additional group filter](#)
- [XCP - AUTOSAR Single Pointer Method – single page, checksum by INCA](#)
- [Import ES6xx module parameters from Excel \(CSV\)](#)
- [Recorder – Add Calibration Info to support Big Data - Monitoring devices](#)
- [Prof - XCP on FlexRay Flashing](#)
- [Updated OBD and WWH-OBDODX projects according to latest SAEJ1979-DA 2019-05](#)
- [Reconfiguration of XETK/FETK during Hardware Initialization](#)
- [INCA-SIP - Basic Support of FMU-Blocks](#)
- [INCA - Migration of machine based FNP licenses to FNE licenses](#)
- [Support of Windows Server as OS](#)

# INCA V7.3 – What's New

## Overview of Functionality added by Service Packs



### Links to Functionality Description of Service Pack 5

- [iLinkRT V3 – Multi Client Test Bench Support](#)
- [iLinkRT COM Master - FLOAT64 Support](#)
- [COM-API – Allow INCA FLOW parallel to ASAP3](#)
- [ASAP2 – Keyword CALIBRATION ACCESS](#)
- [ASAP2 – Keyword ALIGNMENT FLOAT16 IEEE](#)
- [Support of ETH host port to connect Vector HW to INCA PC](#)
- [Make CAN Controller configurable active/passive for CAN/CAN-FD Monitoring/trace](#)
- [Make CAN Controller Self-Reception configurable for CAN/CAN-FD Monitoring/trace](#)
- [Support of multiple Autosar ECU extract files 3rd release](#)
- [XETK/FETK Overload Error Behavior Configuration in INCA](#)
- [xETK Config Tool – Logging/Error Window](#)
- [VN5620 Support](#)
- [VN891x support](#)
- [VN8972 support](#)

# INCA V7.3 – What's New

## Overview of Functionality added by Service Packs



### Links to Functionality Description of Service Pack 6

- [MCE – iLinkRT V3: Change Workspace / Hex File](#)
- [Autosar – Support of multiple ECU extract files – Some IP Monitoring](#)
- [XCP – DAQ configuration optimization - optimize ODT entries to save RAM](#)
- [Recorder – Date/Time, Index, short comment as variables for measure file name](#)
- [Enhanced A2L/Autosar check for Flexray buffer configuration XCP Master](#)
- [XCP – Support of HOST\\_NAME keyword](#)
- [Store the Database Tree view for each Database](#)
- [ETAS License Manager – Migration wizard for new license technology](#)
- [ETK – Advanced Code Check](#)

# INCA V7.3 – What's New

## Overview of Functionality added by Service Packs



### Links to Functionality Description of Service Pack 7

- [Vector Ethernet Network Support \(Network-based mode\), enabling SomeIP and PDU \(Ethernet\) Monitoring](#)
- [XCP – Resume Mode support via Tool API](#)
- [COM-API – New Methods to control the Default Recorder](#)
- [XCP V1.0 – Minimum Raster Check for Dynamic DAQ](#)
- [AUTOSAR – I-SIGNAL Array Support \(ISO8859-1 encoding\)](#)
- [Recorder – MDF V4 – Add Signal precision by ASAP2 Format information](#)
- [ES850 – Measurement Module for A/D and Thermo Channels](#)
- [VN7640 Support](#)
- [INCA-SIP – MDF-Write functionality](#)
- [MATLAB – Support of MATLAB 2021B](#)

# INCA V7.3 – What's New



## Multi-Dimensional Measurements - ASAP2 LAYOUT

### Change of INCA default Behavior

INCA will change its default behavior for measurement arrays without LAYOUT from COLUMN\_DIR to ROW\_DIR to be conform to ASAP2 standard.

If the ASAP2 measurement description contains the LAYOUT info INCA respects the given memory orientation.

If LAYOUT is missing INCA interprets multi-dimensional measurement arrays by default dependent on INCA version and ASAP2 version.

INCA / ASAP2	V1.5	V1.6.1	V1.7
V7.2.x	COLUMN_DIR	COLUMN_DIR	COLUMN_DIR
V7.3.2	COLUMN_DIR	COLUMN_DIR	COLUMN_DIR
V7.3.3 ff.	COLUMN_DIR	COLUMN_DIR	ROW_DIR

[Further information](#)

### Recommendation

The creators of A2L files shall use always the optional ASAP2 keyword LAYOUT to describe the orientation exactly!

Available with INCA V7.3 SP3

# INCA V7.3 – What's New

## General Data Protection Regulation



### Compliance to General Data Protection Regulation

Please note that personal data is processed when using INCA. As the controller, the purchaser undertakes to ensure the legal conformity of these processing activities in accordance with Art. 4 No. 7 of the General Data Protection Regulation (GDPR). As the manufacturer, ETAS GmbH is not liable for any mishandling of this data.

### Data categories

Please note that INCA particularly records the following personal data (categories), and/or data (categories) that can be traced back to a specific individual, for the purposes of assisting with troubleshooting

- Communication data: IP address, date and time
- User data: The user's Windows UserID

Further information to this topic is available in the INCA installation handbook and the INCA online help.

# INCA V7.3 – What's New



## INCA Training

### **Seminars offered at ETAS locations worldwide or at customer site**

Deep skills and sound knowledge are essential prerequisites for handling software tools of ever-rising complexity. Our trainers are highly experienced engineers in the field of engineering and support, who relish sharing knowledge on ETAS products and development processes. Target groups for the trainings are beginners, advanced users and those who wish to expand their existing knowledge.

### **INCA – Calibration (3 days)**

- Practical operation of the software and the knowledge of the INCA fundamentals
- Get to know the advantages and disadvantages of various calibration concepts

### **INCA - Advanced Calibration Techniques (2 days)**

- Advanced functionalities in INCA, Tips & Tricks. INCA experience is required
- Workshop part, bring in your own problem statement

### **INCA - FLOW Coaching**

- Using your own calibration tasks to see the benefits of INCA-Flow in your daily work

Some ETAS local offices have their own training programs which are specialized for the local needs. Please contact our local office of your area for the details: <https://www.etas.com/en/trainings.php>



# INCA V7.3 – What's New

## Virtual Machines



### Usage of virtual PC machines

The usage of INCA on a virtual machine (VM) is restricted and not recommended:

- The VM needs sufficient working memory (RAM), otherwise the performance of INCA goes down
- Access to sufficient graphic card memory (Direct X) is necessary, otherwise the oscilloscope representation of measurement signal is not possible
- Access to hardware interfaces Ethernet, USB, PCMCIA, ... is necessary, otherwise INCA cannot use the connected hardware
- Measure samples may be lost and the accuracy of time stamps is not guaranteed as the higher task priority for hardware access (Target Server) is not given
- ETAS does no special tests concerning VM machines

ETAS recommends to use real PC hardware.

# INCA V7.3 – What's New

## Licensing



### Shift from FlexNet Publisher to FlexNet Embedded Licenses

Step-by-step migration, for a smooth migration

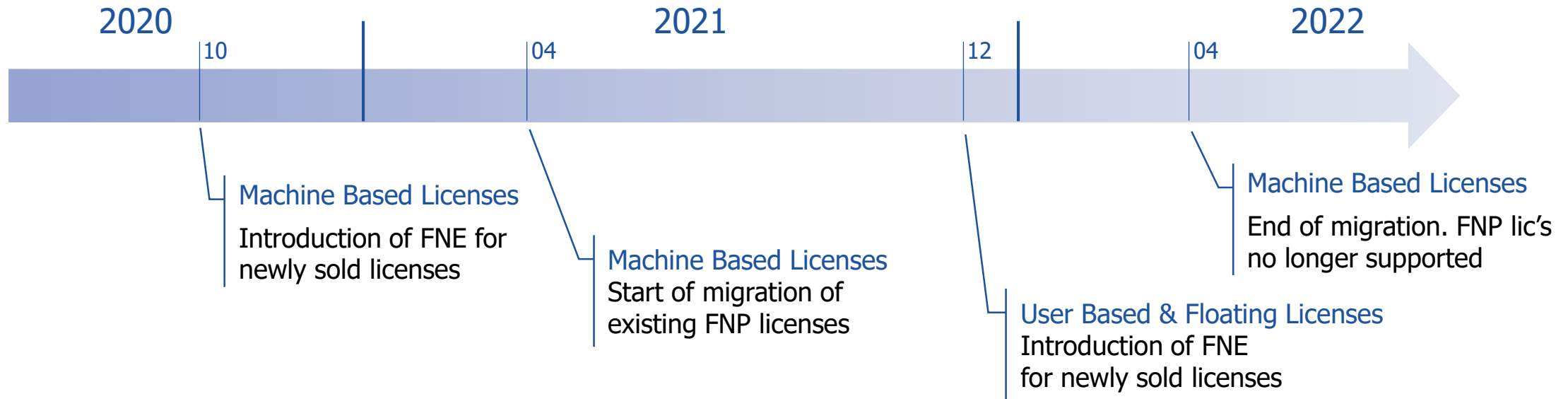

<b>Machine</b>	<b>FNP</b>	<b>FNP &amp; FNE</b>		<b>FNE</b>
<b>User / Floating</b>	<b>FNP</b>		<b>FNP &amp; FNE</b>	<b>FNE</b>

# INCA V7.3 – What's New

## System Requirements



### Minimum System Requirements

- 2 GHz Processor, 2 GB RAM, and DVD-ROM drive \*)
- Graphics: at least 1024x768, 256MB RAM, 16bit color and DirectX 9

### Recommended System Requirements

- 3 GHz Quad-Core Processor, 16 GB RAM, and DVD-ROM drive \*)
- Graphics: at least 1280x1024, 1GB RAM, 32bit color and DirectX 9
- Windows 10 64Bit
- Investigation on performance showed
  - More Memory improves execution time of repetitive operations
  - SSD Hard disks improve the file access times

### Supported OS

- Windows 8.1 64Bit
- Windows 10 64Bit (version 1803 or higher)
- Windows 10 64Bit Enterprise (LTSC 2016 or higher)

\*) Needed for installation via DVD only  
Not necessary when installing via network

# INCA V7.3 – What's New

## General Notes



Additionally Installed Components	INCA V7.3
.Net-Runtime-Environment	V4.8 <sup>1)</sup>
VCxRedist (Vcredist_x86 / Vcredist_x64)	VC9 <sup>6)</sup> + VC10 <sup>6)</sup> + VC14 + VC16 <sup>6)</sup>
JAVA SDK Version j2sdk1.4.2_11	X <sup>2)</sup>
Perl V5.30.0	X
ETAS Certificate	X
Direct X	V9 (or higher)
ETASShared	13
Windows 8.1 64 bit	X <sup>3) 5)</sup>
Windows 10 64bit	X <sup>3)</sup>
Windows Server 2016 64Bit / 2019 64Bit	X <sup>4)</sup>
<p><sup>1)</sup> This component is installed only when no or an older version is installed. If a newer version is already installed, it will not be touched. This is checked by a Microsoft installation routine.</p> <p><sup>2)</sup> This component is installed only with ODX LINK</p> <p><sup>3)</sup> For hardware driver support see release notes</p> <p><sup>4)</sup> Starts with INCA V7.3 SP4; INCA FLOW, INCA RDE is not released for Windows Server</p> <p><sup>5)</sup> .NET V4.8 needed (available from Microsoft Support <a href="#">.NET V4.8</a>)</p> <p><sup>6)</sup> INCA V7.3 SP7: VC9, VC10 removed and VC16 added</p>	



Thank you