

LABCAR-OPERATOR V5.4.4

Getting Started



Copyright

The data in this document may not be altered or amended without special notification from ETAS GmbH. ETAS GmbH undertakes no further obligation in relation to this document. The software described in it can only be used if the customer is in possession of a general license agreement or single license. Using and copying is only allowed in concurrence with the specifications stipulated in the contract.

Under no circumstances may any part of this document be copied, reproduced, transmitted, stored in a retrieval system or translated into another language without the express written permission of ETAS GmbH.

© **Copyright 2017** ETAS GmbH, Stuttgart

The names and designations used in this document are trademarks or brands belonging to the respective owners.

V5.4.4 R01 EN - 09.2017

Contents

1	Introduction	5
1.1	About this Manual	5
1.2	Using this Manual	6
1.3	The LABCAR-OPERATOR V5.4.4 Manuals	7
2	LABCAR-OPERATOR – An Overview	9
2.1	Requirements of the Test System	9
2.1.1	Development of Controller Functionality and its Validation	9
2.1.2	The General Architecture of a Test System	11
2.2	LABCAR-OPERATOR	12
2.2.1	The Components of LABCAR-OPERATOR V5.4.4	13
2.2.2	LABCAR-IP	15
2.2.3	ETAS Experiment Environment	18
2.2.4	Migration of Older Projects (V3.2.x and Higher)	21
3	Installation	23
3.1	Preparation	23
3.1.1	Scope of Delivery	23
3.1.2	System Requirements	23
3.1.3	Further Software Requirements	24
3.1.4	User Privileges	24
3.1.5	Displaying HTML-based Content under Windows XP SP2	25
3.2	Program Installation	26
3.2.1	Start Menu	27
3.2.2	Selecting Program Versions	29
3.3	Licensing	32
3.3.1	LABCAR License Models	32
3.3.2	How to Get a License	32
3.4	HSP Update Tool	34

3.5	The Network Connection to the Real-Time PC	35
4	Tutorial	37
4.1	The "IdleController" Model	38
4.2	Creating the LABCAR-OPERATOR Project	40
4.3	Displaying Measure Values and Calibrating Parameters	46
4.4	Configuring Hardware	53
4.5	Adding Inports	57
4.6	Connecting Signals in the Connection Manager	60
4.7	Configuration of the Real-Time Operating System	63
4.8	Running the Experiment	64
4.9	Recording with the Datalogger	70
5	ETAS Network Manager	75
5.1	Overview	75
5.2	ETAS Hardware Addressing	75
5.3	Network Adapter Addressing	76
5.3.1	Type of Network Adapter Addressing	76
5.3.2	Addressing the Network Adapter Manually	76
5.3.3	Addressing the Network Adapter via DHCP	76
5.4	User Interface	77
5.4.1	Configuration Dialog Window 1 — Selection of Network Adapter ("Network settings for ETAS hardware (page 1)")	77
5.4.2	Configuration Dialog Window 2 — Defining the Address Pool ("Network settings for ETAS hardware (page 2)")	79
5.4.3	Configuration Dialog Window 4 — Displaying Warning ("Network settings for ETAS hardware (Page 4)")	80
5.5	Configuring Network Addresses for ETAS Hardware	81
5.5.1	Manually configuring the Network Adapter	81
5.5.2	Auto-Configuring Network Adapter for ETAS Hardware	83
5.5.3	Enabling APIPA in the Registry	85
6	ETAS Contact Addresses	87
	Index	89

1 Introduction

This manual addresses qualified personnel working in the fields of automobile ECU development and testing. Specialized knowledge in the areas of measurement and ECU technology is required.

1.1 About this Manual

This manual contains information on getting started with LABCAR-OPERATOR V5.4.4.

The manual consists of the following chapters:

- "Introduction" on page 5
This chapter
- "LABCAR-OPERATOR – An Overview" on page 9
This chapter provides you with an overview of the requirements made of test systems for controllers in the automotive sector and the resulting architecture of LABCAR-OPERATOR and its components.
- "Installation" on page 23
This chapter contains information on the scope of delivery, hardware and software requirements for installation and on how to prepare for the installation.
- "Tutorial" on page 37
This chapter uses a simple example to show you how to create a LABCAR-OPERATOR project and then work with it.
- "ETAS Network Manager" on page 75
This chapter describes the ETAS Network Manager that helps you address ETAS hardware in your network.

1.2 Using this Manual

Presentation of Information

All actions to be performed by the user are presented in a so-called "use-case" format. This means that the objective to be reached is first briefly defined in the title, and the steps required to reach the objective are then provided in a list. This presentation looks as follows:

Definition of objective

Any preliminary information...

- Step 1
Any explanation for Step 1...
- Step 2
Any explanation for Step 2...
- Step 3
Any explanation for Step 3...

Any concluding remarks...

Specific example:

To create a new file

When creating a new file, no other file may be open.

- Choose **File** → **New**.
The "Create file" dialog box is displayed.
- Type the name of the new file in the "File name" field.
The file name must not exceed 8 characters.
- Click **OK**.

The new file will be created and saved under the name you specified. You can now work with the file.

Typographic Conventions

The following typographic conventions are applied:

Choose File → Open .	Menu options are printed in bold, blue characters.
Click OK .	Button labels are printed in bold, blue characters.
Press <ENTER>.	Key commands are printed in small capitals enclosed in angle brackets.

The "Open file" dialog box appears.	The names of program windows, dialog boxes, fields, etc. are enclosed in double quotes.
Select the <code>setup.exe</code> file.	Text strings in list boxes, in program code and in path and file names are printed using the <code>Courier</code> font.
A conversion between Logic and Arithmetic data types is <i>not</i> possible.	Emphasized text portions and newly introduced terms are printed in an <i>italic</i> font face.

Important notes for users are presented as follows:

Note

Important note for users.

1.3 The LABCAR-OPERATOR V5.4.4 Manuals

The following LABCAR-OPERATOR V5.4.4 manuals are available:

- **LABCAR-OPERATOR V5.4.4 - Getting Started**

This manual

- **LABCAR-OPERATOR V5.4.4 - User's Guide**

This manual contains a complete description of all LABCAR-OPERATOR V5.4.4 functions including instructions on how to operate these functions.

- **LABCAR-RTC V5.4.4 - User's Guide**

This manual describes the creation and parameterization of hardware configurations for HiL test systems.

The manuals are provided as PDF files on your installation DVD and can also be accessed using the [Help](#) menu. Using the index, full-text search, and hypertext links, you can find references fast and conveniently.

2 LABCAR-OPERATOR – An Overview

This chapter provides you with an overview of the requirements made of test systems for controllers in the automotive sector and the resulting architecture of LABCAR-OPERATOR and its components.

2.1 Requirements of the Test System

This section deals with the requirements made of the test system and the resulting architecture. A test system is a system which is used to validate and verify the unit referred to as "controller".

2.1.1 Development of Controller Functionality and its Validation

Fig. 2-1 shows the controller as it is embedded in the vehicle and how it interacts with it. In addition, the overall model also involves the interaction of the vehicle with the driver and the interaction of the driver and the vehicle with the environment.

The block referred to as "controller" in the control engineering description in Fig. 2-1 basically contains the control algorithms, the monitoring and diagnostic functions. It can also have interfaces to the outside world which do not interact with the other components, e.g. diagnostics and measure and calibration interfaces.

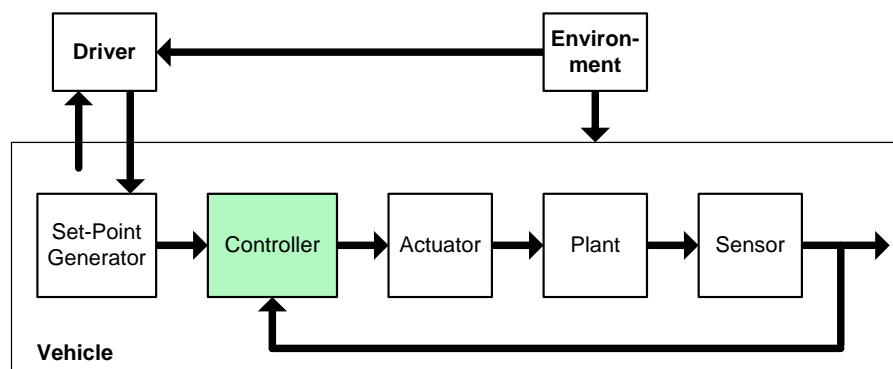

Fig. 2-1 Driver, Vehicle and Environment (DVE)

An important requirement for testing controller functionality is the simulation of driver, vehicle and environment, or DVE for short. Tools which make systematic and automated tests possible are also necessary.

Another factor which has to be taken into consideration is that, during its development, an increasing number of "interfaces" have to be operated for the controller (referred to more generally hereafter as the "unit under test" (UuT)) and parts of the DVE simulation are replaced by real components (actuators, sensors).

If the UuT initially consists entirely of control algorithms, other interfaces are gradually added as development progresses:

- monitoring and diagnostics
- calibration

The UuT is subjected to major modifications, especially in terms of its complexity, during its development. It starts as a model of a subfunctionality and extends (via the physical ECU) to a complete ECU network.

The Evolution of the UuT in the Development Process

Fig. 2-2 shows the different levels of complexity the UuT runs through during its development.

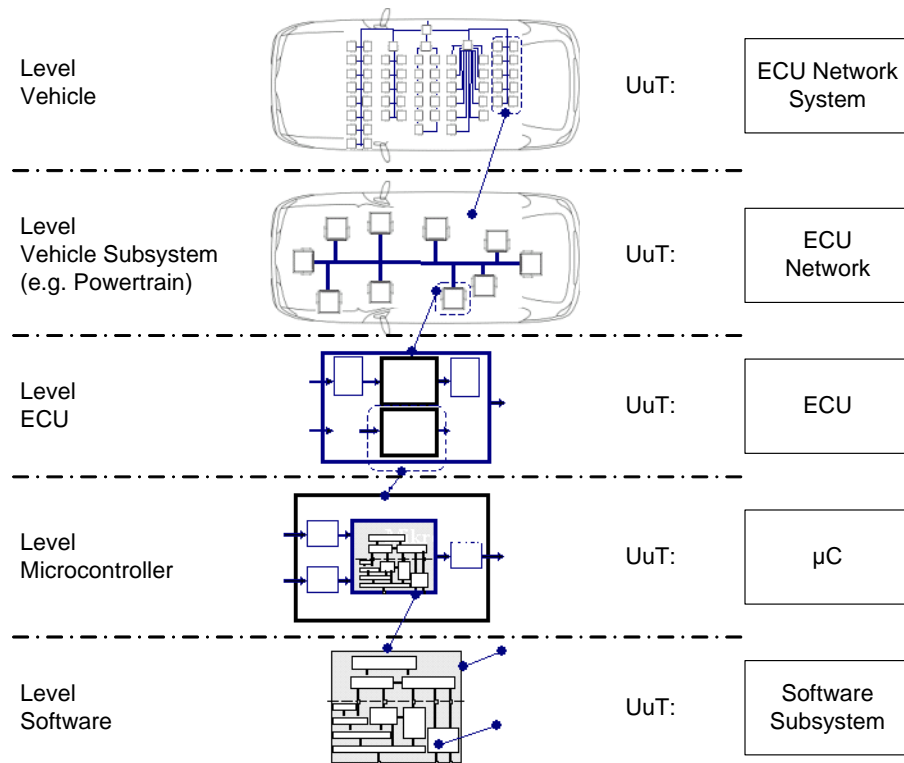

Fig. 2-2 The Evolution of the UuT in the Development Process

- Software component and subsystem
In this stage of development, the UuT consists of a software model of a controller functionality.
- Microcontroller and ECU
In the next two stages, the UuT consists of a hardware controller or a complete ECU. Here, the UuT is either software realized on a target (microcontroller) or it is already present physically as an ECU.
- ECU network of a vehicle subsystem or the overall vehicle
At the highest stage, the UuT consists of networks of ECUs which control subsystems of the vehicle or the entire vehicle.

2.1.2 The General Architecture of a Test System

This results in the general architecture of a test system for controller development shown in Fig. 2-3.

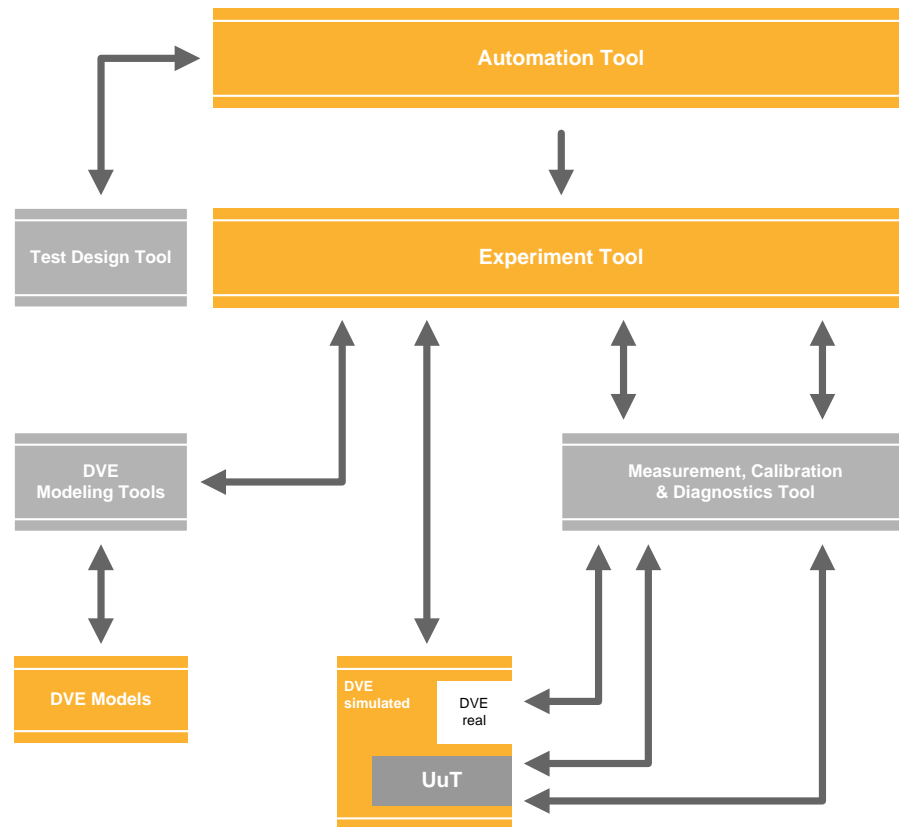

Fig. 2-3 General Architecture of a Test System

- In the center is the **experiment** which is composed of the UuT and the simulation of driver, vehicle and environment (DVE).
- This experiment is managed, controlled and assigned an instrumentation by the **experiment software**.
- This experiment software can usually be addressed with an **automation tool** which enables complex, automated tests and test evaluation.
- A **modeling tool** is used to create and edit the DVE model or modeled controller functionality.
- **Measurement and calibration tools** enable direct access to the UuT.
- Diagnostic interfaces of the UuT are accessed with a **diagnostic tool**.

This architecture provides all functionalities of a test system that are usually necessary for managing and controlling the experiment, adapting the model to the changing stages of development of the UuT and accessing interfaces of the UuT.

2.2 LABCAR-OPERATOR

LABCAR-OPERATOR was developed taking into consideration the fundamental requirements described above of a system for developing and validating controller functionality.

Its main functions are:

- Integration platform (LABCAR-IP) for function modules of various kinds:
 - MATLAB/Simulink models
 - ASCET modules
 - I/O hardware modules
 - C code modules
 - CAN, LIN and FlexRay modules
 - FiL modules
 - modules for open-loop access and signal handling
- ETAS Experiment Environment (ETAS EE) for Hardware-in-the-Loop applications with
 - comprehensive instrumentation possibilities
 - real-time Signal Generator and Datalogger
 - visualization of the data flow from the ECU via the I/O hardware, sensor/actuator configuration and simulation model
 - add-ons for accessing the ECU via measure and calibration or diagnostic interfaces (INCA)
- Remote control of tests with LABCAR-AUTOMATION

2.2.1 The Components of LABCAR-OPERATOR V5.4.4

Fig. 2-4 shows the structure and components of LABCAR-OPERATOR V5.4.4.

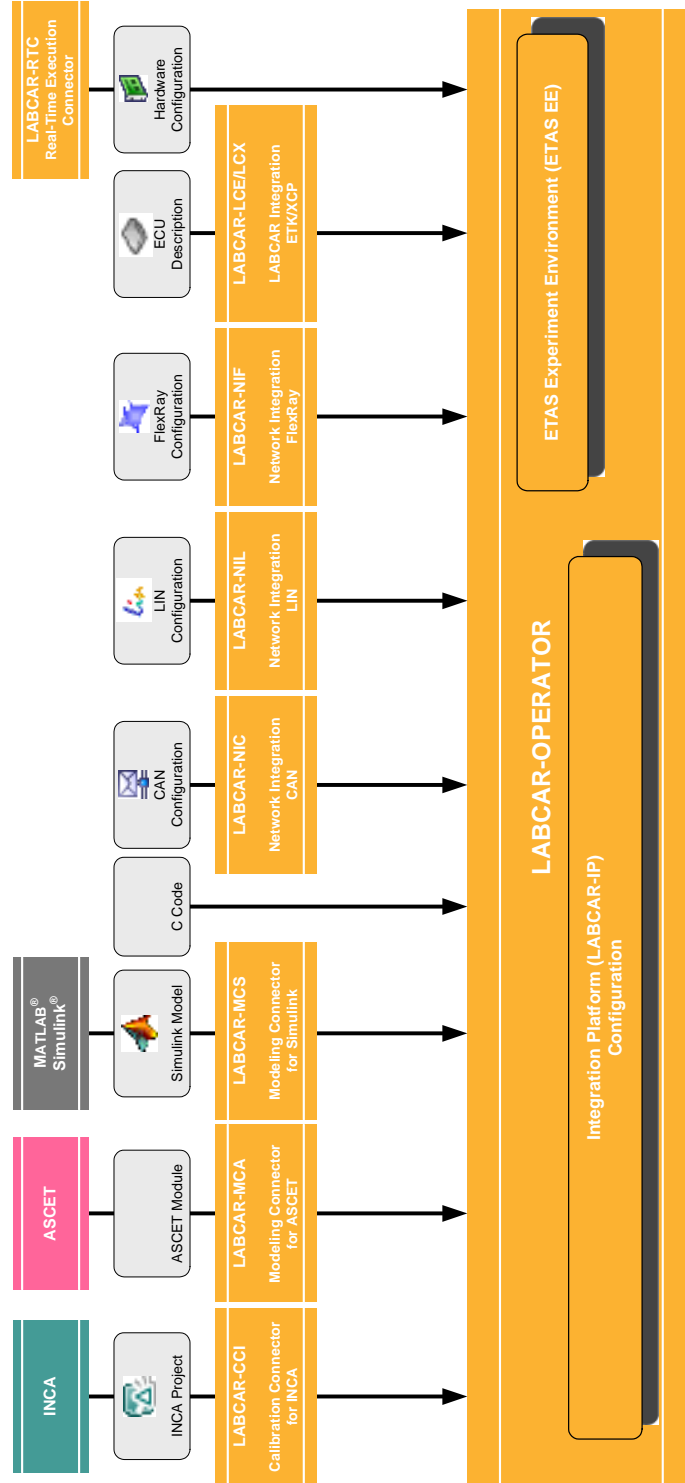

Fig. 2-4 Architecture of LABCAR-OPERATOR V5.4.4

This section describes the LABCAR-OPERATOR V5.4.4 add-ons shown in Fig. 2-4.

LABCAR-MCA V5.4.4 (Modeling Connector for ASCET)

In LABCAR-OPERATOR V5.4.4, ASCET projects that were previously exported from ASCET (V6.0.1) for the target "RTPC" can now also be integrated as modules. After code generation in LABCAR-IP, the measure variables and parameters are available in the experiment environment ETAS EE.

LABCAR-MCS V5.4.4 (Modeling Connector for Simulink)

The Modeling Connector for Simulink makes it possible to use Simulink models directly - with a minimum of extensions to the model. The project is managed entirely in LABCAR-OPERATOR. All project information and configurations are created and stored here.

The Simulink model can be used both for Model-in-the-Loop and Hardware-in-the-Loop experiments. The model has what are referred to as **LABCAR Inports** and **LABCAR Outports** for both uses: These make it possible to connect model signals to each other but also model signals to hardware signals.

For HiL applications, there is a **Connection Manager** available for exactly this purpose. This is where the user can see both all inputs and outputs of the Simulink model (if they have been assigned LABCAR Inports and Outports) and the signals of the configured hardware. The connections between the model and the hardware are created and edited here.

This configuration is saved in the project context of LABCAR-OPERATOR - the Simulink model is unaffected by the relevant hardware configuration. This means that connections to the hardware can be modified as required without the model code having to be regenerated. Only the code for the modified hardware or for the changed connections in the Connection Manager has to be regenerated.

The user also has a default OS configuration at his disposal - changes to OS configurations should be executed in **OS Configurator** by experts.

LABCAR-RTC V5.4.4 (Real-Time Execution Connector)

LABCAR-RTC V5.4.4 has to have been installed if you want to use LABCAR-OPERATOR V5.4.4 with hardware components in real-time experiments.

The Real-Time Execution Connector is used to integrate and parameterize hardware components used in HiL tests. In online mode, the signal flow through the hardware channels can also be visualized and hardware settings adjusted. The saved hardware information is displayed in the LABCAR-OPERATOR environment.

LABCAR-CCI V5.4.4 (Calibration Connector for INCA)

LABCAR-CCI V5.4.4 enables the user to connect the LABCAR experiment with an INCA project to be able to access INCA data in the experiment - INCA labels of the experiment are available for visualization in LABCAR-OPERATOR V5.4.4.

Together with the ETAS measuring and calibration tools, this makes direct ECU access possible - interfaces are also available for the remote control of INCA via LABCAR-OPERATOR V5.4.4.

Note

An INCA license is not part of the delivery package.

LABCAR-NIC V5.4.4 (Network Integration CAN)

LABCAR-NIC V5.4.4 makes it possible to configure a simulated residual CAN bus and to exchange CAN messages with the bus in the experiment.

LABCAR-NIL V5.4.4 (Network Integration LIN)

LABCAR-NIL V5.4.4 makes it possible to configure a simulated residual LIN bus and to exchange LIN messages with the bus in the experiment.

LABCAR-NIF V5.4.4 (Network Integration FlexRay)

LABCAR-NIF V5.4.4 enables you to integrate data extracted previously using the EB tresos Busmirror into your LABCAR-OPERATOR project in order to be able to work with the signals of the FlexRay module.

LABCAR-LCE V5.4.4 (LABCAR Integration ETK)

LABCAR-LCE V5.4.4 enables the creation and integration of FiL modules. In an FiL system, some (or all) electric connections are bypassed and the ECU memory is accessed directly – the ECU must be equipped with an ETK for this purpose.

LABCAR-LCX V5.4.4 (LABCAR Integration XCP)

LABCAR-LCX V5.4.4 enables the creation and integration of FiL modules for the direct ECU access via XETK or XCP on CAN.

2.2.2 LABCAR-IP

The integration platform of LABCAR-OPERATOR V5.4.4 is mainly used to

- import modules with different functions into one project,
- configure the I/O hardware module,
- connect between these modules, and
- generate code for the simulation target "RTPC".

In addition, the following take place:

- OS settings are made for real-time simulation
- Signal Generator Sets are created for stimulating inputs in open-loop experiments

The User Interface

The LABCAR-IP user interface consists of the following:

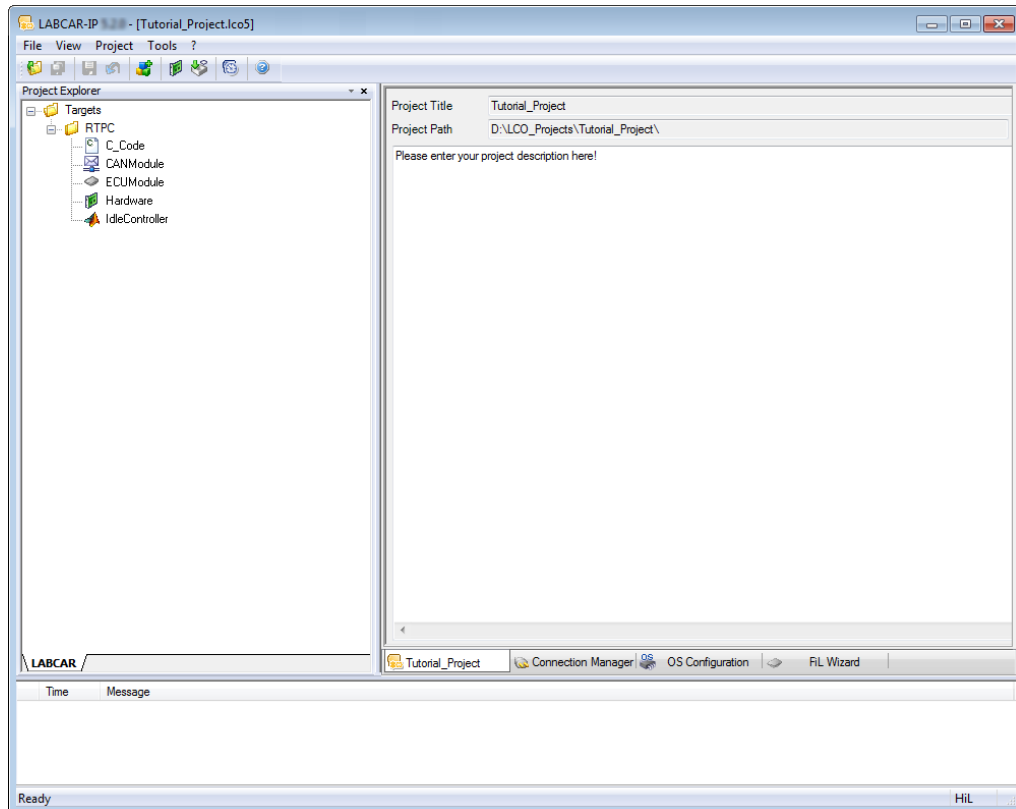

- The **Project Explorer**, which contains all parts of the LABCAR-OPERATOR project
- The **main workspace**, which makes the important parts of LABCAR-IP accessible (via a range of tabs):
 - the general **project information**
 - the **Connection Manager** for connecting signals and inserting modules for signal conversion
 - the **CAN Editor** for configuring the residual bus simulation (only if LABCAR-NIC V5.4.4 is installed and the CAN module has been opened)
 - the **LIN Editor** for configuring the residual bus simulation (only if LABCAR-NIL V5.4.4 is installed and the LIN module has been opened)
 - the **FlexRay Editor** for configuring the residual bus simulation (only if LABCAR-NIF V5.4.4 is installed and the FlexRay module has been opened)
 - the **OS Configuration** for configuring the operating system
 - the **FIL Wizard** for configuring Fil modules
- The **"Messages" window**, with information, error messages etc. on actions and connected hardware.

Modules

A module consists of:

- signal inputs
- signal outputs
- functionality (in the form of code)
- measure variables
- parameters
- processes, the execution of which is planned in the task administration of the real-time experiment

The following kinds of modules can be used in LABCAR-OPERATOR V5.4.4:

- **ASCET models**
ASCET models can be integrated with LABCAR-MCA V5.4.4.
- **Simulink models**
Simulink models can be integrated with LABCAR-MCS V5.4.4.
- **C code modules**
Any user-specific C code can also be integrated as a module.
- **CAN modules**
Modules for the residual bus simulation can be created and processed with LABCAR-NIC V5.4.4 (Network Integration CAN).
- **LIN modules**
Modules for the residual bus simulation can be created and processed with LABCAR-NIL V5.4.4 (Network Integration LIN).
- **FlexRay modules**
Modules for the simulation of a FlexRay bus can be integrated using LABCAR-NIF V5.4.4 (Network Integration FlexRay).
- **FiL modules**
Modules for ECU access with an ETK/XETK can be created and integrated with LABCAR-LCE V5.4.4.
- **Hardware module**
The familiar RTIO module for configuring the I/O hardware; is created and can be edited with LABCAR-RTC V5.4.4 (Real-Time Execution Connector).
- **Modules for signal conversion**
Newly introduced in LABCAR-OPERATOR V5.4.4, this considerably simplifies the modeling of sensors/actuators in open-loop operation.

2.2.3 ETAS Experiment Environment

ETAS Experiment Environment (ETAS EE) is the environment for configuring (instrumentation, parameterization etc.) and executing experiments.

The new experiment environment offers the following possibilities:

- clear access to all parameters and measure variables due to the combination of the "Element List" and "Signal Center" in the "Workspace Elements" window
- creation of instrumentations for displaying measure variables and for modifying parameters of the running experiment
- signal conversion and sensor/actuator modeling
- tracing signal paths
- data recording with the Datalogger
- stimulating inputs with the Signal Generator

The "Workspace Elements" Window

In LABCAR-OPERATOR V5.4.4, the "Element List" and the "Signal Center" have been combined in a single view, "Workspace Elements".

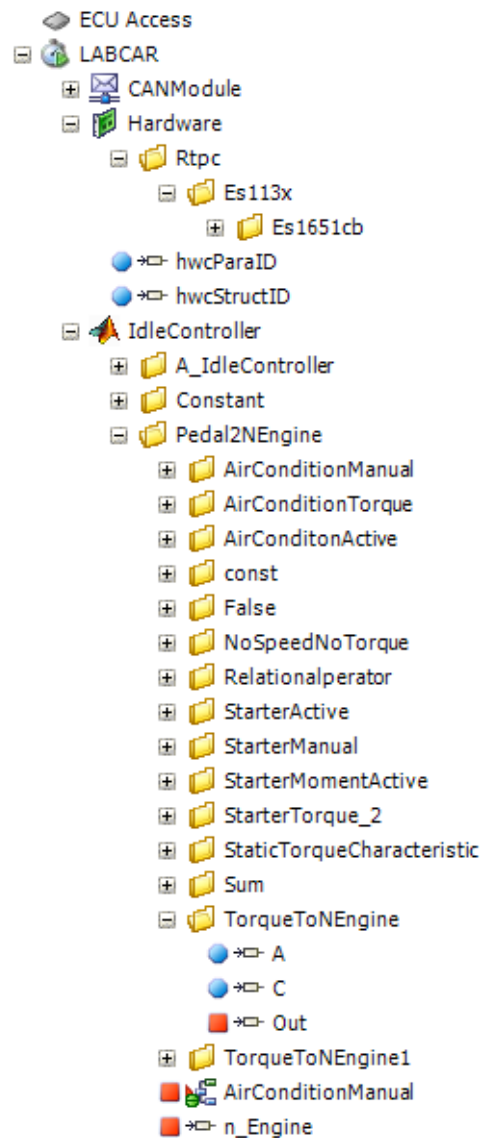

Fig. 2-5 A Section of "Workspace Elements"

This is where the user can access

- measure variables
- parameters
- inputs
- outputs
- and
- hardware pins

of the active experiment.

In this view it is easy to search signals, parameters and measure variables, as well as the hierarchies of the modules. The filter function and search function of the "Workspace Elements" window also help you.

Instrumentation

The set of instruments for displaying measure variables and inputting parameters has been extended considerably: A new real-time oscilloscope has also been developed.

Open-Loop Operation and Signal Editing

The resolute standardization of the parts of the HiL experiment in the form of modules makes systematic intervention in the signal trace possible.

Generic actuator/sensor modules (based on C code modules) can be used at any point in the signal trace. Every input can be used to interrupt the signal chain and to stimulate the input with constant values or values from the Signal Generator.

ETAS EE contains the "Signal List" for managing, tracing and editing signals.

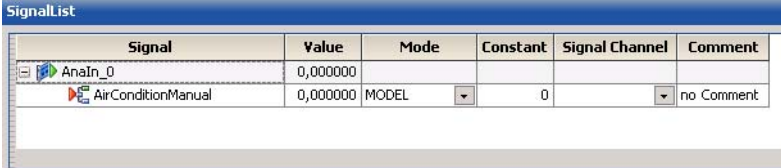

Signal	Value	Mode	Constant	Signal Channel	Comment
AnaIn_0	0,000000				
AirConditionManual	0,000000	MODEL	0		no Comment

Once a signal has been added to the Signal List, the following actions can be carried out here:

- tracing the signal trace
- defining the mode: model, constant value or connection of a Signal Generator for open-loop operation.

2.2.4 Migration of Older Projects (V3.2.x and Higher)

Projects created with LABCAR-OPERATOR V3.2.x and higher have automatically been migrated up to LABCAR-OPERATOR V5.1.2. This is no longer possible from version V5.2.x.

Note

If you want to open such a project with LABCAR-OPERATOR V5.4.4, you must first open it in version V5.1.x, migrate it and re-save it.

When the old project is opened in LABCAR-IP, the "Migration Wizard" is launched – it executes all necessary steps.

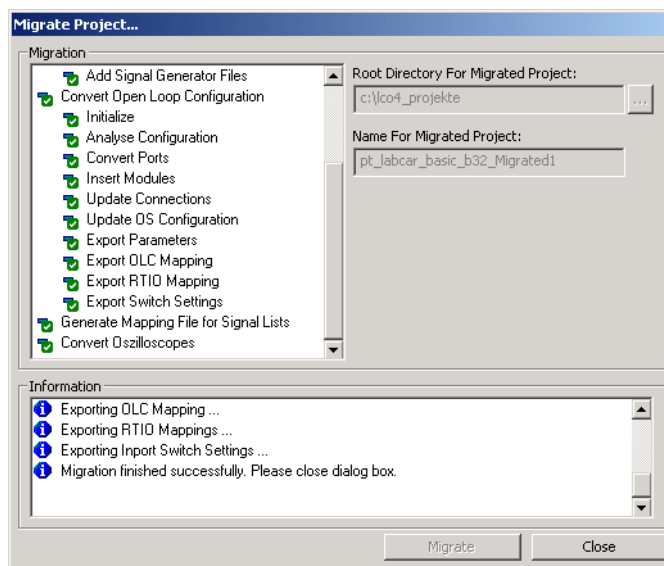

The successfully migrated project is then stored in the directory previously selected under the selected name.

Limitations

The automatic migration of projects does not work if

- the project (LABCAR-OPERATOR V3.2.x) contains a LABCAR-DEVELOPER project or
- with projects with simulation target ES1130

This kind of project must be recreated in LABCAR-OPERATOR V5.4.4.

3 Installation

This chapter contains information on the scope of delivery, hardware and software requirements for installation and on how to prepare for the installation.

3.1 Preparation

Check that the delivery package you receive contains everything it should and that your PC meets the system requirements. Depending on the operating system and network connection, you have to ensure that you have the necessary user privileges.

Note

Artefacts of LABCAR software projects contain personal data (e.g. user name of the creator or operator). An example are log files generated during runtime. Therefore the user is responsible for compliance with (local) laws and regulations, like the fulfillment of legal requirements for deletion of personal data.

3.1.1 Scope of Delivery

LABCAR-OPERATOR V5.4.4 is supplied with the following:

- LABCAR-OPERATOR V5.4.4 DVD-ROM
 - LABCAR-OPERATOR V5.4.4 program files
 - The current Hardware Service Pack (HSP)
 - LABCAR-OPERATOR V5.4.4 manuals in PDF format
 - Manuals of current LABCAR hardware in PDF format
 - What's New, Release Notes and additional documentation
- The "LABCAR-OPERATOR V5.4.4 - Getting Started" manual
- A document ("License Entitlement") that describes how to get the licenses for the software components purchased.

3.1.2 System Requirements

The following system requirements are necessary for the operation of LABCAR-OPERATOR V5.4.4:

- Hardware:
 - Intel Pentium Dual-Core 2 GHz processor or higher
 - Min. 4 GB RAM; 8 GB recommended
 - Hard disk 20 GB (at least 5 GB free space)
 - DVD-ROM drive (for the installation)
 - Graphics card compatible with DirectX 9 or higher - resolution 1280x1024, 16-bit colour or higher
 - Ethernet board (10/100BaseT)

- Operating systems:
 - Windows 7 SP1 (32-bit or 64-bit)
 - Windows 8.1 (64-bit)
 - Windows 10

The following language versions of these operating systems are supported:

- English
- German
- French
- Japanese
- Korean

3.1.3 Further Software Requirements

The current list of the software versions required for operating LABCAR-OPERATOR V5.4.4 is in the menu ? → **Help** in the document "LABCAR-OPERATOR 5.x.y - Software Compatibility List".

3.1.4 User Privileges

Please observe the following information on user privileges required for installation and operation of LABCAR-OPERATOR.

User Privileges Required for Installation

- You must have administrator privileges to install products of LABCAR-OPERATOR on a PC. If in doubt, ask your system administrator.
- You must have a directory for temporary files on your PC (e.g. C:\TEMP) to which all users working with LABCAR-OPERATOR on this PC have both read and write access.

User Privileges Required for Operation

- To work with products of LABCAR-OPERATOR, every user has to receive the "Increase Scheduling Priority" privilege from the administrator. If you have already installed INCA, you may well have already organized this for some users during installation (see figure).
- All LABCAR-OPERATOR users must have write access to the registration key "HKEY_LOCAL_MACHINE\SOFTWARE\Microsoft\Cryptography\ RNG" as well as full access to the "HKEY_LOCAL_MACHINE\SOFTWARE\ETAS" key and the keys of all subdirectories.
- All users of LABCAR-OPERATOR and the default user "Everyone" must have full access rights to the \ETAS folder, its subfolders and all the files in them. This is absolutely necessary for code generation with the GNU C-Compiler.

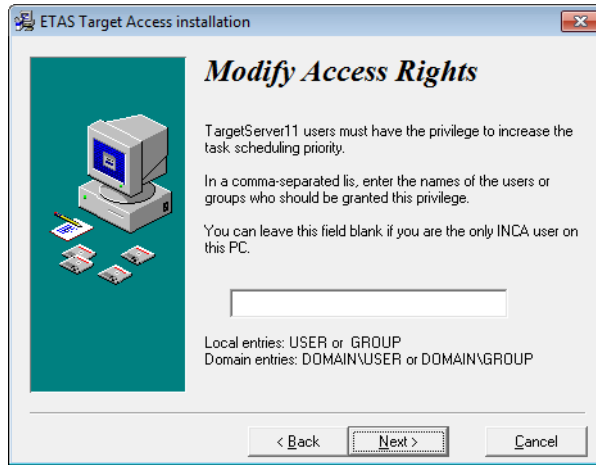

3.1.5 Displaying HTML-based Content under Windows XP SP2

Make sure that the "Allow active content to run in files on My Computer" option is enabled.

These settings are in the Control Panel under "Internet Properties" in the "Advanced" tab.

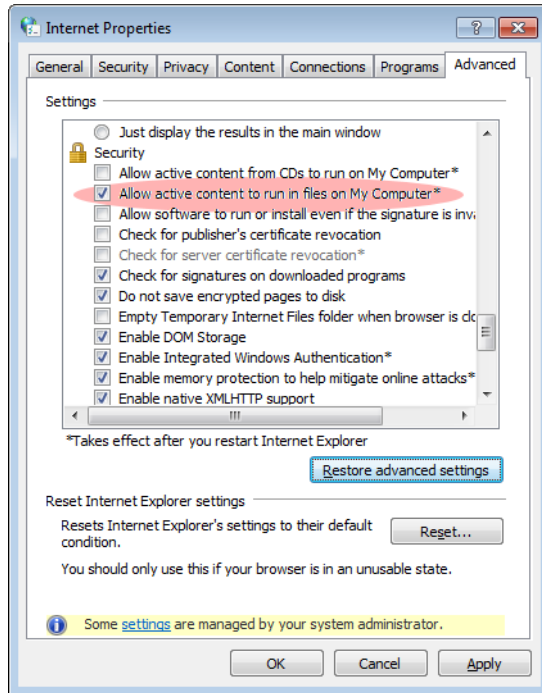

3.2 Program Installation

This section describes how to install LABCAR-OPERATOR V5.4.4.

To install LABCAR-IP

- Insert the product DVD in your DVD-ROM drive. The DVD-Browser is launched.
- Select **Installation** → **Install LABCAR-OPERATOR**. You can install the HSP (Hardware Service Pack) later (see "HSP Update Tool" on page 34). The welcome window opens.

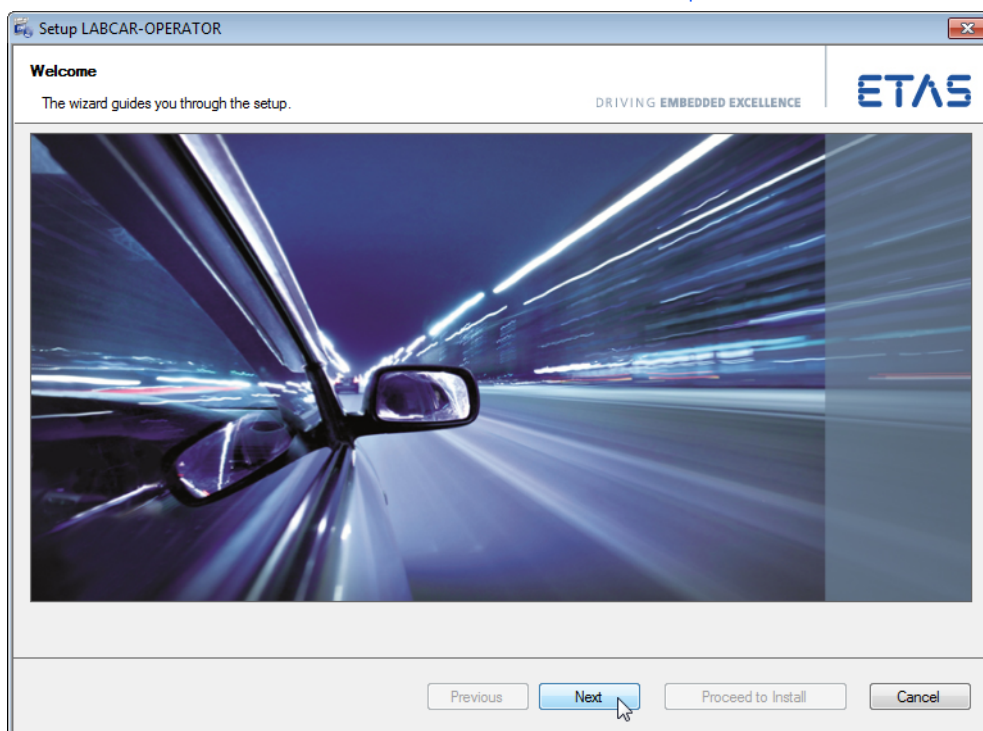

- Click **Next** and follow the instructions of the installation wizard.

- To complete the installation click **Finish**.

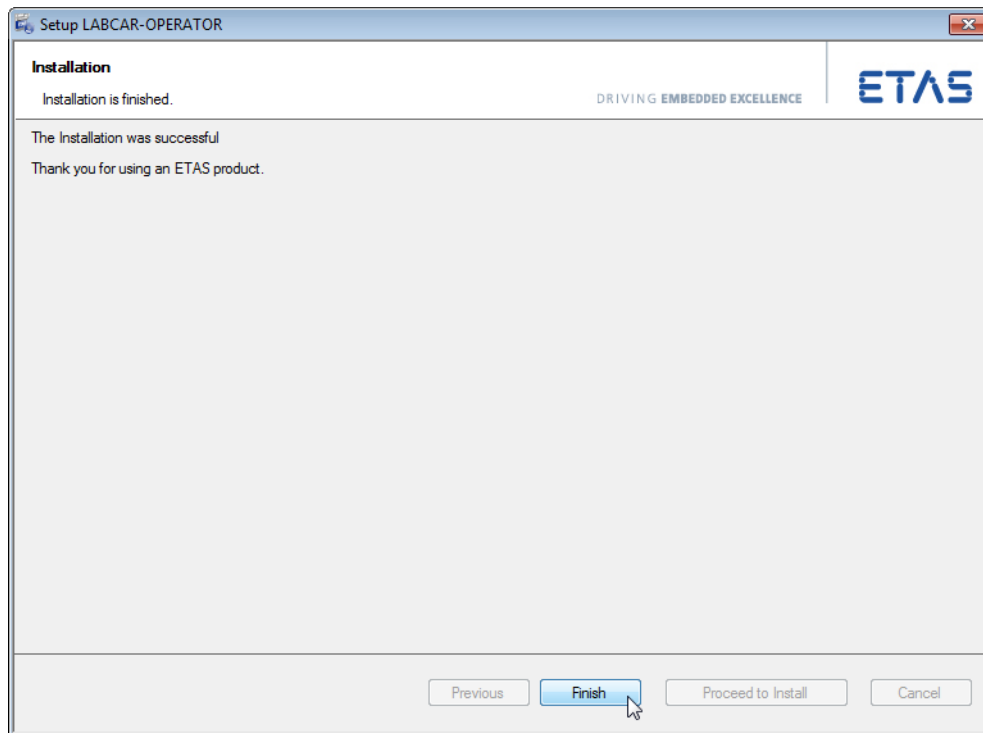

3.2.1 Start Menu

The Start menu folder **All Programs** → **ETAS** → **LABCAR-OPERATOR X.Y** contains the following entries once installation has been completed successfully:

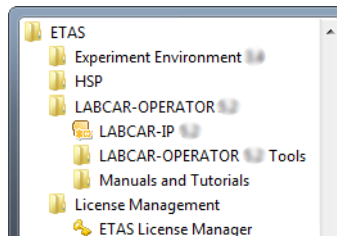

- **LABCAR-IP**
Launches the integration platform
- **LABCAR-OPERATOR Tools**
Opens the LABCAR-OPERATOR directory `\LCO Tools`, from where the following tools can be started:
 - **LABCAR-OPERATOR Version Selector**
This is where you can toggle between the versions (see "To select the LABCAR-OPERATOR version" on page 29)
 - **MATLAB Version Selector**
This is where you can select the MATLAB version to be used (see "To select the MATLAB version" on page 30)

- **RT-Plugin Builder**
Starts an application for creating real-time plugins.
- **Manuals and Tutorials**
Opens an File Explorer window for `\ProgramData\ETAS\ETASManuals\`, which contains a link to the manuals of LABCAR-OPERATOR and LABCAR hardware.

The Start menu folder **All Programs** → **ETAS** → **Experiment Environment X.Y** contains the following entries:

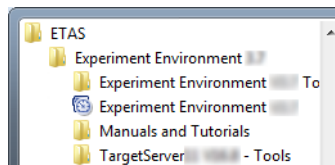

- **Experiment Environment VX.Y Tools**
Opens the Experiment Environment directory `\EE Tools`, from where the following tools can be started:
 - **Associate to INCA**
Opens a dialog window which connects ETAS EE with a specific INCA version (see "To select the INCA version" on page 31).
 - **Associate to RTA Trace**
Opens a dialog window which connects ETAS EE with a specific RTA Trace version.
- **Experiment Environment VX.Y**
Launches the experiment environment ETAS EE.
- **Manuals and Tutorials**
Opens an File Explorer window for `\ProgramData\ETAS\ETASManuals\`, which contains a link to the HTML help documents for ETAS EE.
- **TargetServernn Tools**
Opens the directory `\ETAS\TargetServernn\Tools`, from where the following tools can be started:
 - **Search for connected hardware**
The target server is launched and a search for connected hardware is executed.
 - **ETAS Network settings**
Launches the ETAS Network Manager for configuring your network card(s) for the ETAS hardware and other networks (see "ETAS Network Manager" on page 75).

3.2.2 Selecting Program Versions

To complete the installation, you should now specify which versions of the software employed in the LABCAR-OPERATOR environment should be used. This applies both to the LABCAR-OPERATOR version itself and the version of Matlab/Simulink and INCA.

To select the LABCAR-OPERATOR version

If you have installed several versions of LABCAR-OPERATOR, you can specify the version to be used. To do so, proceed as follows:

- If LABCAR-IP is open, close it.
- From the Windows Start menu, select **Programs** → **ETAS** → **LABCAR-OPERATOR X.Y** → **LABCAR-OPERATOR VX.Y Tools** → **LABCAR-OPERATOR Version Selector**.

The LABCAR-OPERATOR Version Selector opens.

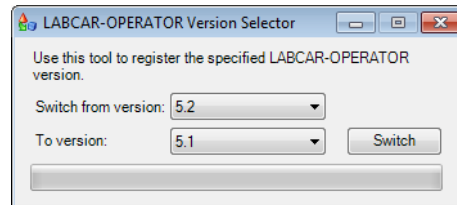

- Select the version to be used and click **Switch**.
If the change is successful, the following message is displayed.

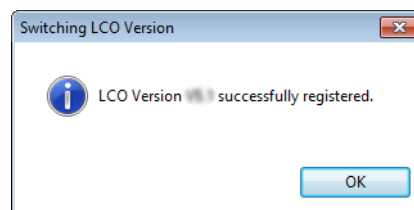

Note

Always use the LABCAR Version Selector from the current LABCAR-OPERATOR version – otherwise double registry entries may cause problems.

To select the MATLAB version

If you have installed several versions of Matlab/Simulink, you can specify the version to be used (in the integration of Simulink models). To do so, proceed as follows:

- From the Windows Start menu, select **All Programs** → **ETAS** → **LABCAR-OPERATOR X.Y** → **LABCAR-OPERATOR VX.Y Tools** → **Matlab Version Selector**.

The "Select Matlab Version" window opens.

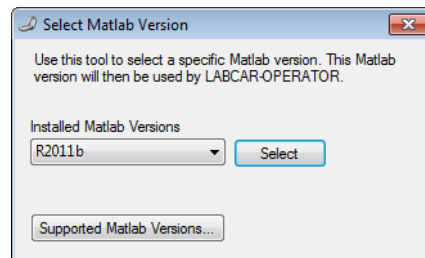

- Select the version to be used from the "Installed Matlab Versions" list.
- To display the versions supported by LABCAR-OPERATOR V5.4.4, click **Supported Matlab Versions**.
- To save your selection, click **Select**.
The successful selection is confirmed.
- Click **OK** to exit the Matlab Version Selector.

To select the INCA version

If you have installed several versions of INCA, you can specify the version to be used (for accessing INCA experiments with LABCAR-CCI V5.4.4). This selection is executed during installation of the experiment environment (ETAS EE) but can be changed at any time. To do so, proceed as follows:

- From the Windows Start menu, select **All Programs** → **ETAS** → **Experiment Environment X.Y** → **Experiment Environment VX.Y Tools** → **Associate to INCA**.

The "Associate to INCA" window opens.

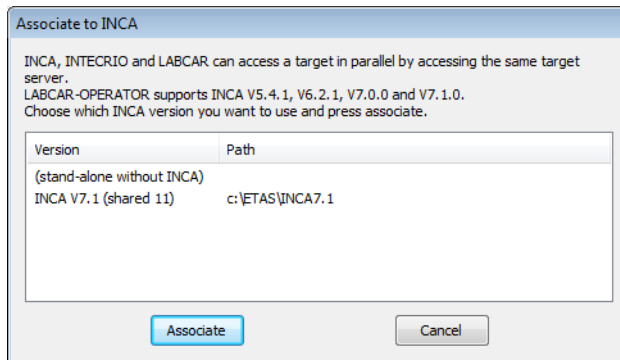

- Select the version to be used from the list.
- To save your selection, click **Associate**.
- The installation of the ETAS Target Server starts.
- Follow the instructions of the installation routine.
- If applicable, enter any other users who should also have the right to increase scheduling priority.

For more details see "User Privileges Required for Operation" on page 24.



- Click **Next**.
- The target server is installed.

3.3 Licensing

To be able to work with an ETAS software product, you require a license. This section contains basic details on this subject. Details concerning the scope of the licenses and other legal aspects can be found in "Terms and Conditions".

3.3.1 LABCAR License Models

There are two different license models available for licensing your LABCAR software:

Machine-Named License, Local

- A license of this type is managed by the user him/herself.
- As it is linked to a particular PC (better: to the MAC address of the Ethernet adapter), it is valid wherever the PC is used.
- When you change your PC, you require a new license.

Concurrent (or Floating) License, Server-Based

Most of what is true of the user-named license applies to this type of license. The difference is that here several users share a limited number of licenses.

3.3.2 How to Get a License

If your company has a tool coordinator and server-based license management for ETAS software, contact this person. Otherwise (in the case of a machine-named license) you obtain your license from the ETAS license portal (the URL is shown on your Entitlement Certificate).

There are three ways of logging in on the welcome page:

- **Activation ID**
Once you have logged in, a specific activation¹ is visible and can be managed – the activation ID is shown on your Entitlement Certificate.
- **Entitlement ID**
All activations of the entitlement² are visible and can be managed (e.g. for a company with just one entitlement).
- **E-mail and password**
All activations of the entitlements assigned to the user account are visible and can be managed (e.g. for a tool coordinator responsible for several entitlements).

If you need help in the portal, click the [Help](#) link.

¹. The activations refer to a specific product, its license conditions, the available number of licenses and other details required for generating a license. Activations are identified uniquely with activation IDs.

². An entitlement shows the authorizations you have as a user; it stands for the right to own one or more licenses for a product. It is a kind of account of rights of use for software from which you can take licenses as you need to.

What Information is Required?

Information on the hosts must be entered to activate licenses:

- Machine-named license
The MAC address of the Ethernet adapter to which the license is to be bound is required here
- Concurrent (floating) license
Here, you need a server host or a server triad.

Note

If this data changes (e.g. due to changes in the hardware or a change of user), the license must be given a "rehost". This procedure is also described in the portal help file.

License File

The result of your activities is the provision of a file `<name>.lic` with which you can license your software in the ETAS License Manager.

To check license status

- In the Windows Start menu, select **Programs** → **ETAS** → **License Management** → **ETAS License Manager**.

The ETAS License Manager is opened.

The ETAS License Manager contains one entry for each installed product. The symbol at the beginning of the entry and the "Status" column entry indicate whether a valid license has already been obtained or not.

Product	Feature	Status	Feature Version	Source	Expiration Date
Experiment Environment	EE	Installed	3.0	Borrow	30.04.2017
Experiment Environment	INT_RP_EE	Installed	3.0	Borrow	30.04.2017
Experiment Environment	INT_UCC_LCO_FIL	Installed	3.0	Borrow	30.04.2017
Experiment Environment	INT_VP_EE	Installed	3.0	Borrow	30.04.2017
Experiment Environment	LCS_LCO_CCI	Installed	5.0	Borrow	30.04.2017
Experiment Environment	LCS_LCO_LCE	Installed	5.0	Borrow	30.04.2017
LABCAR-OPERATOR	LCS_LCO_LCE	Installed	5.0	Borrow	30.04.2017
Experiment Environment	LCS_LCO_LCX	Installed	5.0	Borrow	30.04.2017
LABCAR-OPERATOR	LCS_LCO_LCX	Installed	5.0	Borrow	30.04.2017
LABCAR-OPERATOR	LCS_LCO	Installed	5.0	Borrow	30.04.2017
LABCAR-OPERATOR	LCS_LCO_MCA	Installed	5.0	Borrow	30.04.2017
LABCAR-OPERATOR	LCS_LCO_MCS	Installed	5.0	Borrow	30.04.2017
LABCAR-OPERATOR	LCS_LCO_NIC	Installed	5.0	Borrow	30.04.2017
LABCAR-OPERATOR	LCS_LCO_NIF	Installed	5.0	Borrow	30.04.2017
LABCAR-OPERATOR	LCS_LCO_NIL	Installed	5.0	Borrow	30.04.2017
LABCAR-OPERATOR	LCS_LCO_RTC	Installed	5.0	Borrow	30.04.2017

- Further information on licence management can be found in the online help (<F1>).

3.4 HSP Update Tool

The HSP Update Tool is supplied so you can update your hardware to the latest firmware version (with the most recent Hardware Service Pack from your product DVD).

To execute installation

- Insert the product DVD in your DVD-ROM drive.
The DVD browser is launched.
- Select **Installation** → **Install HSP <version no.>**.

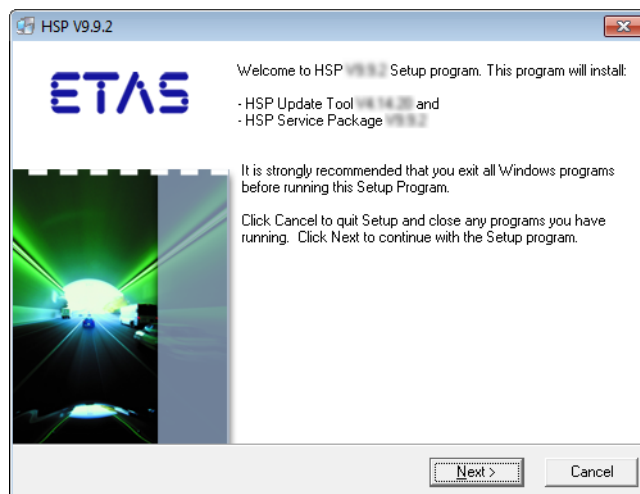

- Click **Next**.
The installation procedure starts.
- Follow the instructions in the dialog boxes.
- Click **Finish** to complete the installation.

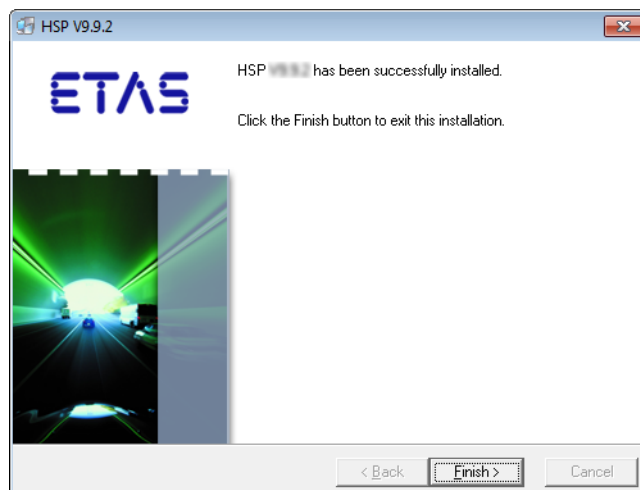

To run a firmware update

- Launch the HSP Update Tool in LABCAR-IP using **Tools** → **HSP Update Tool**.

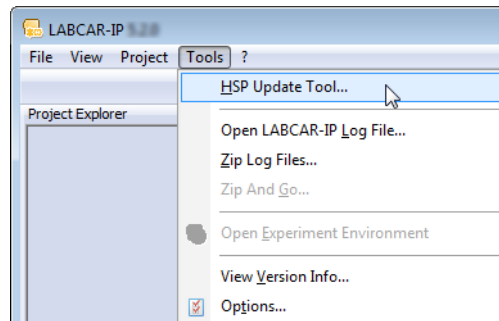

The HSP Update Tool is launched.

- Select **Help** → **Quick Start**.
A help window with instructions on running the update opens.
- Run the firmware update as described.

3.5 The Network Connection to the Real-Time PC

The connection between your user PC and the target "RTPC" takes place via a second Ethernet board in the user PC and the "ETH0" port of your Real-Time PC. Then configure the board in your user PC with the fixed network address 192.168.40.240 (subnet mask: 255.255.255.0)

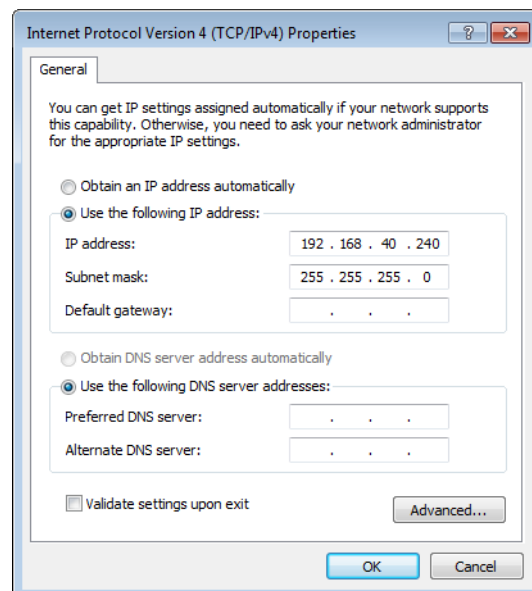

For more details refer to the "ETAS RTPC V6.3.1 - User's Guide" and the chapter "ETAS Network Manager" on page 75.

4 Tutorial

This chapter uses a simple example to show you how to create a LABCAR-OPERATOR project and then work with it.

This tutorial is structured as follows:

- "The "IdleController" Model" on page 38
This section contains a short description of the Simulink model "IdleController.mdl" used for this project.
- "Creating the LABCAR-OPERATOR Project" on page 40
This section describes the basic steps when creating a project with LABCAR-MCS V5.4.4 (Modeling Connector for Simulink).
- "Displaying Measure Values and Calibrating Parameters" on page 46
In this section, you will create a display element for engine speed and a switch with which the air conditioning can be switched on and off.
- "Configuring Hardware" on page 53
The scope of this tutorial does not allow for creating a real HiL experiment – this section demonstrates how to work with the tools and use the functions of LABCAR-MCS in this sphere of implementation.
- "Adding Inports" on page 57
Before you can connect the hardware with model signals, you must add LABCAR inports or outports to the model.
- "Connecting Signals in the Connection Manager" on page 60
The signal of the A/D converter ("0" or "1") is then connected to the model input "AirConditionManual" in the Connection Manager.
- "Configuration of the Real-Time Operating System" on page 63
LABCAR-OPERATOR creates a standard OS configuration for every new project in which all the necessary tasks are available and all processes are assigned accordingly.
- "Running the Experiment" on page 64
This section contains a description of the last steps you take before running the experiment.
- "Recording with the Datalogger" on page 70
This section contains instructions on how to record signals with the Datalogger.

4.1 The "IdleController" Model

This section contains a short description of the Simulink model "IdleController.mdl" used for this project.

Fig. 4-1 shows the Simulink model used; it consists of a simple engine model, "Pedal2Nengine", and the actual idle controller "A_IdleController".

The input of the controller is the accelerator position from the driver and the engine speed; a pre-defined speed is maintained during idling.

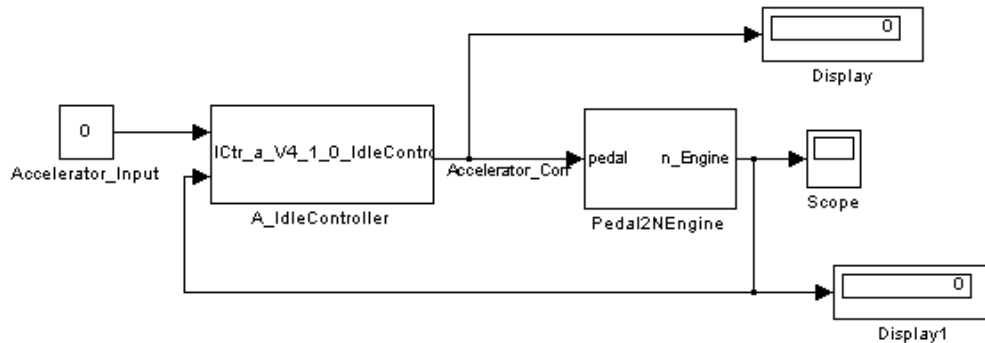

Fig. 4-1 The Overall Model "IdleController.mdl"

In the actual engine model (Fig. 4-2) the accelerator position ("Accelerator_Input") is used to calculate the torque which in turn is used to calculate the engine speed. It is also possible to additionally activate air conditioning which of course requires torque and – particularly during idling - lowers the engine speed. The idle controller becomes active when the engine speed decreases; it provides the engine model with a corrected accelerator position to ensure that the engine speed is readjusted to the target speed required.

The air conditioning is switched according to the value of "AirConditionManual" at the top left in Fig. 4-2. In this tutorial, this value is first modified using a control window and then applied using A/D converter hardware.

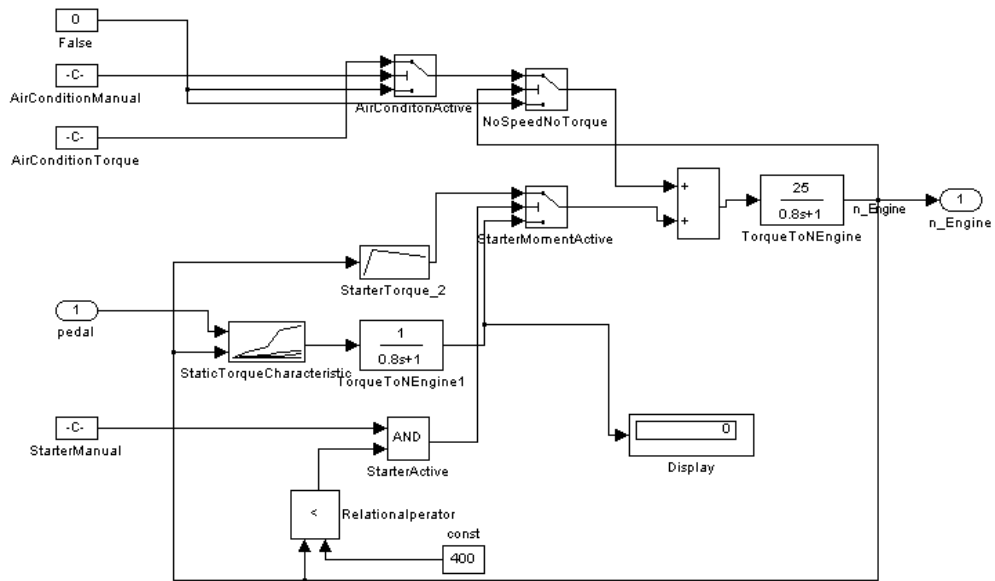

Fig. 4-2 The "Pedal2Nengine" Engine Model

4.2 Creating the LABCAR-OPERATOR Project

This section describes the basic steps when creating a project with LABCAR-MCS V5.4.4 (Modeling Connector for Simulink).

To launch LABCAR-OPERATOR

- Select **Start** → **Programs** → **ETAS** → **LABCAR-OPERATOR X.Y** → **LABCAR-IP**.

or

- Double-click the program icon on your desktop.
LABCAR-OPERATOR is launched and the main window opened.

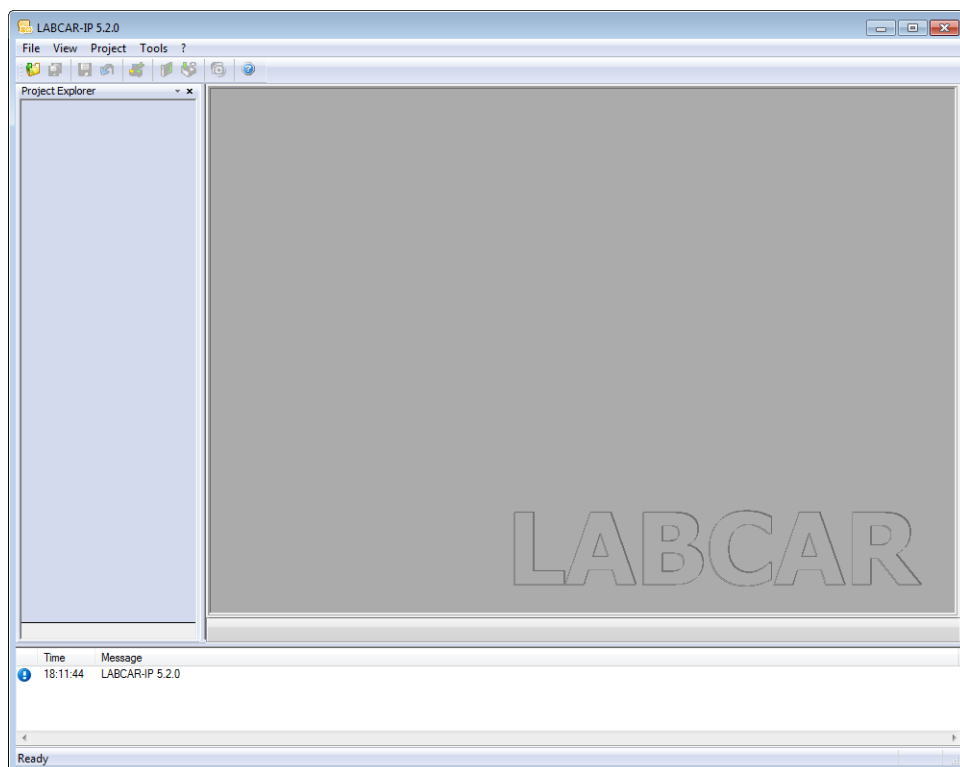

A detailed description of this user interface is contained in the LABCAR-OPERATOR V5.4.4 - User's Guide.

To create a LABCAR-OPERATOR project

- Select **File** → **New Project**.

The Project Wizard opens.

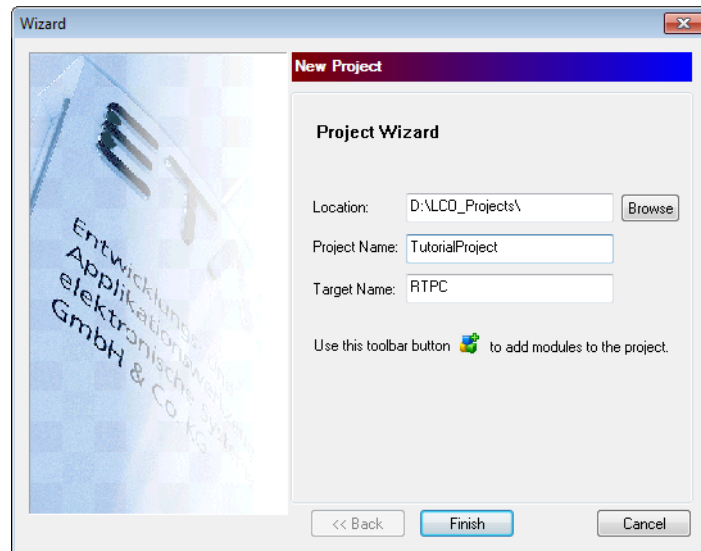

- Select a directory under "Location" in which the new project is to be created.
- Enter a project name under "Project Name".
- If necessary, assign this target a special name under "Target Name".
- Click **Finish**.
The project (without modules and hardware) is created.

To integrate a Simulink model

- Select **Project** → **Add Module**.

or

- Select the **Add Module** icon.



or

- Right-click the Target "RTPC" and select **Add Module** from the shortcut menu.

The Add Module Wizard opens.

- Select the "Add Simulink (TM) Module" option.

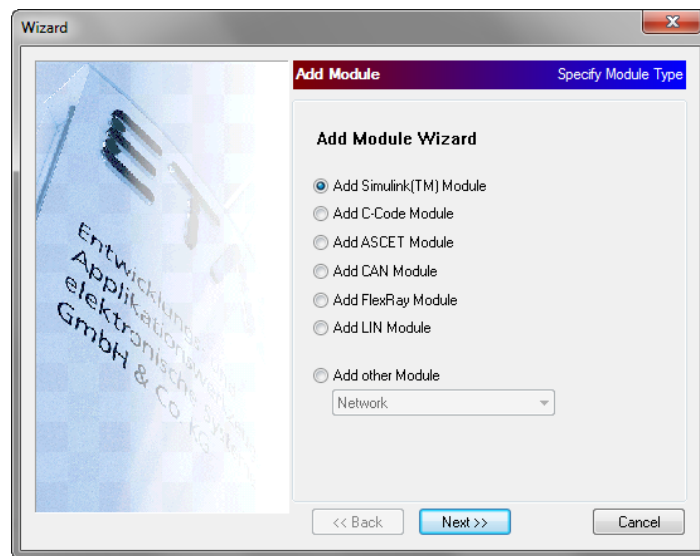

- Click **Next**.

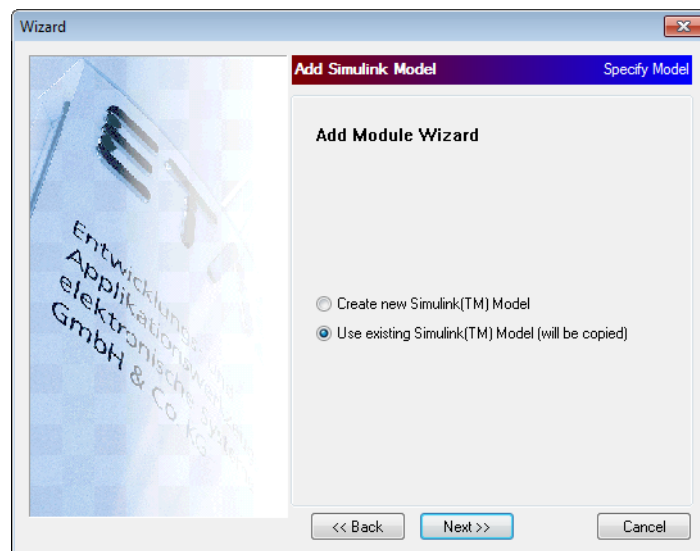

- Select "Use existing Simulink Model".

- Click **Next**.

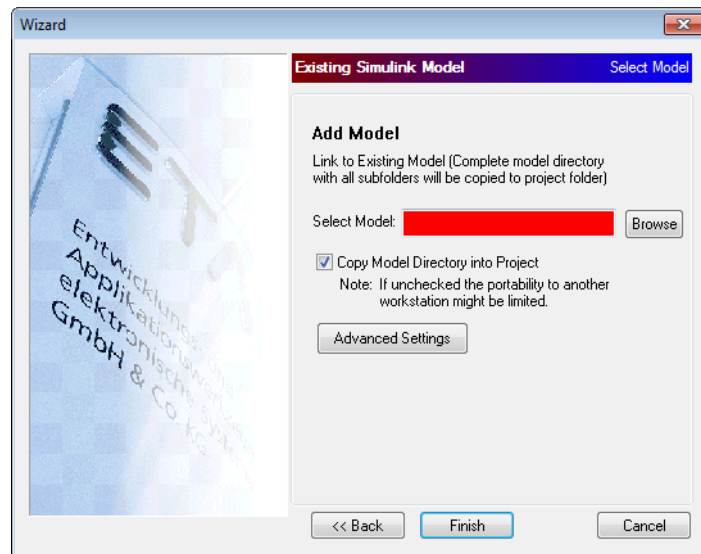

- Use **Browse** to select the Simulink model you want to use.

The "IdleController.mdl" model is in the directory

<drive>:\Program Files\ETAS\
LABCAR-OPERATORX.Y\Manuals\
Tutorial.

- When the option „Copy Model Directory into Project“ is selected, the Simulink model and all corresponding files are copied into the project directory – otherwise the model is only referenced.
- You can make further settings regarding external files and directories using **Advanced Settings** (see LABCAR-OPERATOR V5.4.4 - User's Guide) - this is not necessary, however, for this example.
- Select **Finish**.

The project is created and the relevant directories and files created on your hard disk.

The directory tree of the project is created in the Project Explorer.

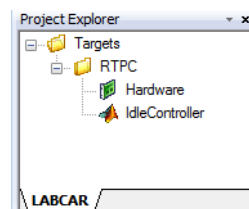

Once the project has been created, the code can be generated.

Note

Make sure that your experimental target is correctly connected and operational!

To generate code

- Select **Project** → **Build...**

or



- Click the **Build LABCAR Project** icon.
- In the following window, select the modules for which code is to be generated.

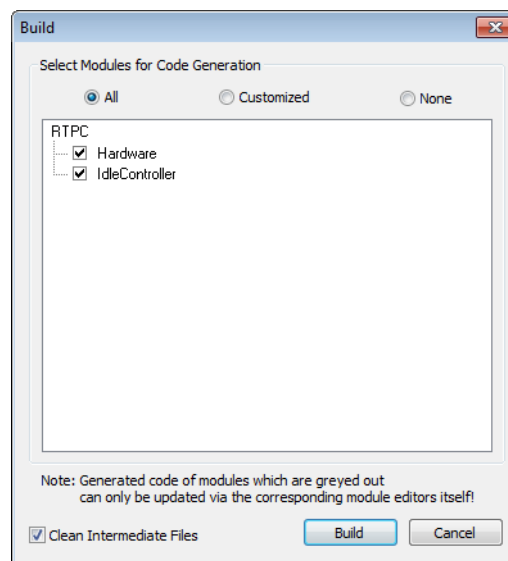

- Click **Build**.

Code is generated for the selected modules.

Successful code generation is then documented in the "Messages" tab.

Time	Message
18:40:28	[BuildSystem]: Finishing subproject libconn.a
18:40:28	[BuildSystem]: Finishing subproject libmisc_code.a
18:40:28	[BuildSystem]: Finishing subproject libmisc_objects.a
18:40:33	[BuildSystem]: Finishing subproject RTPC.hex has already been created on the target...
18:40:34	[BuildSystem]: <Info>: Build finished.
18:41:39	Creating EE workspace...
18:41:49	EE workspace has been created.
18:41:51	Default experiment has been created.

With the successfully generated code, you can now open, configure and run an experiment in the ETAS EE experiment environment.

Note

Once code has been generated for the first time, ETAS EE is launched automatically and a workspace is generated for this experiment.

To start an experiment in ETAS EE



- Click the **Open Experiment Environment** icon. ETAS EE is launched and the experiment opened.

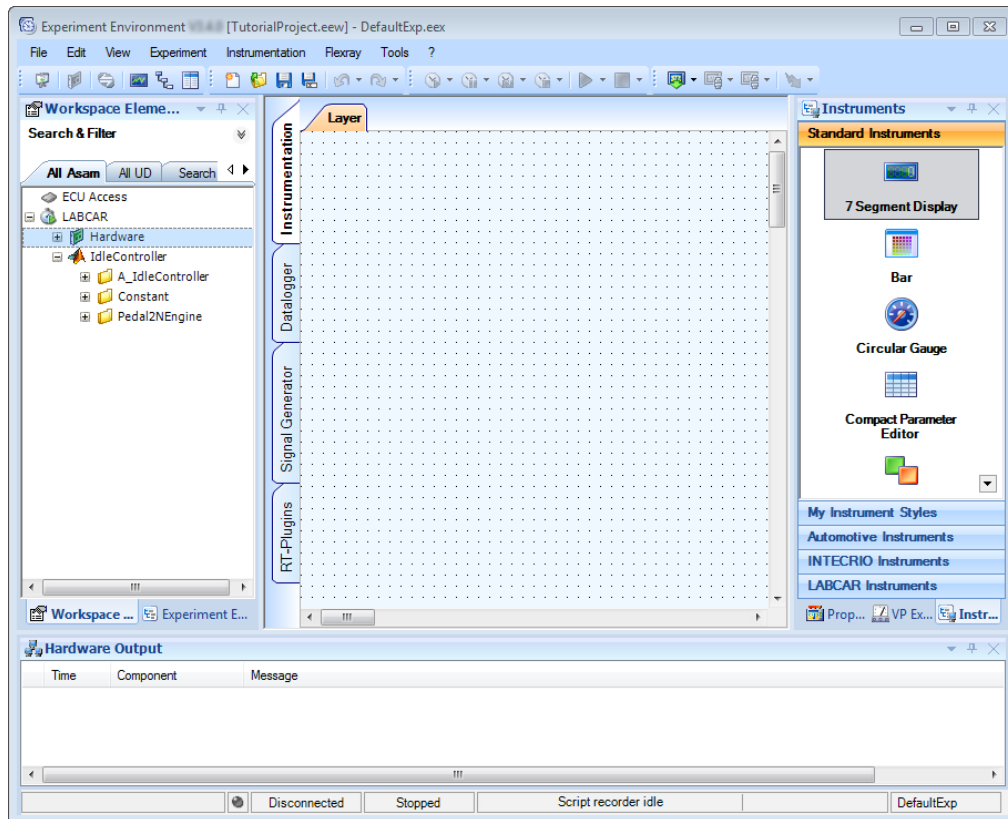

In the "Workspace Elements" window, all parameters, measure variables, inputs and outputs of the model are listed in the corresponding hierarchy.

In the main workspace, you can create the instrumentation (in several "layers"), configure and operate the Datalogger ("Datalogger" tab), and create and operate Signal Generators ("Signal Generator" tab).

4.3 Displaying Measure Values and Calibrating Parameters

In this section, you will create a display element for engine speed and a switch with which the air conditioning can be switched on and off.

To create an oscilloscope



- To create an oscilloscope for displaying the engine speed, click the **Add Oscilloscope** icon in the toolbar.

An oscilloscope window opens.

- Search for the "TorqueToEngine" folder in the "Workspace Elements" window (under "Search&Filter").
- Click through the hierarchy until you see the label "TorqueToEngine\Out".
- Select "Out" and drag it to the oscilloscope window keeping the left-hand mouse button pressed down.

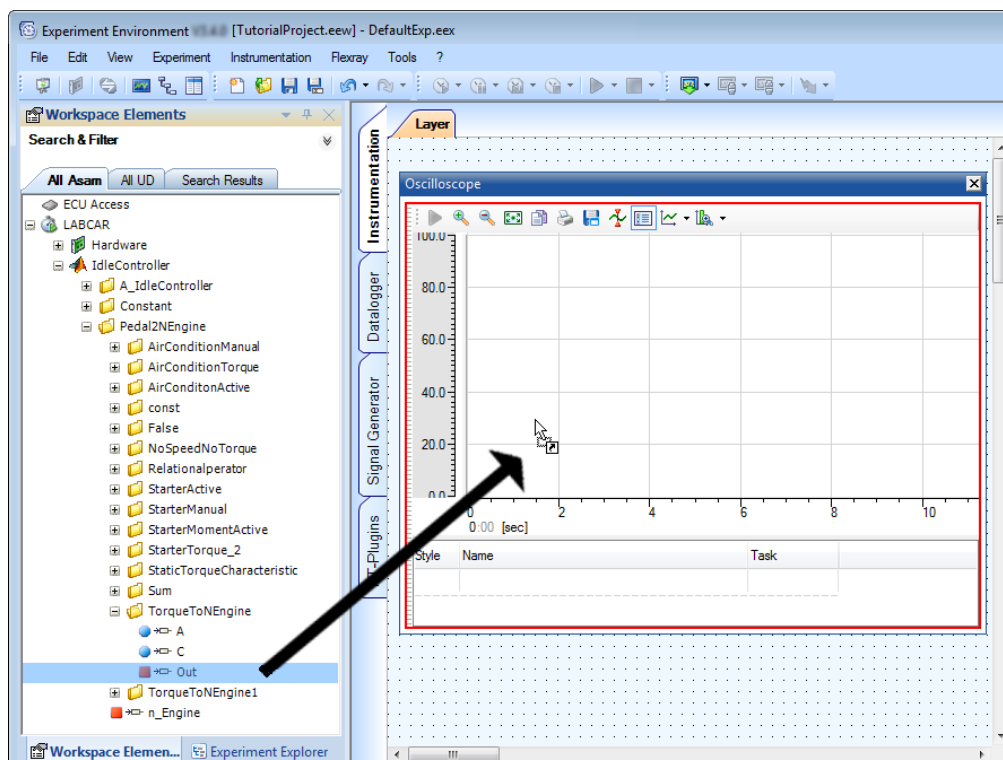

- Release the mouse button over the oscilloscope window.

The "Create Instruments" window opens.

- Select "Acquisition" as task to acquire the measure variable.

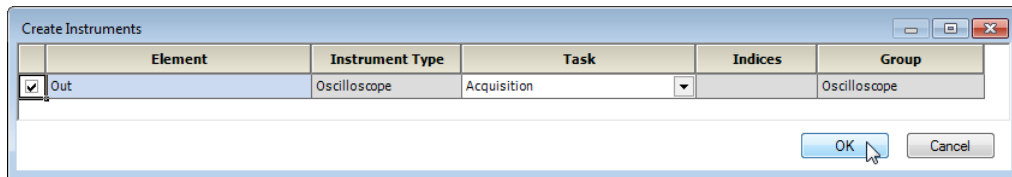

- Click **OK**.

The measure variable is added to the oscilloscope. The name of the variable to be shown is displayed in the legend.

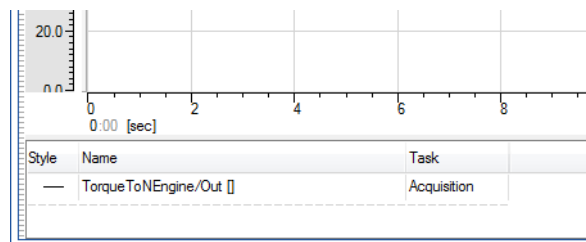

Note

Measure variables are always recorded in the raster of the task they are assigned to - if this raster is less than 5 ms, the following restrictions must be taken into consideration:

1. Continuous recording of measure variables cannot be guaranteed in this range. To ensure continuous recording of measure data, use the Datalogger.
2. The x values (= time) of the measuring points shown may not correspond exactly to this raster - there could be minimal delays.

You will now create a switch with which the air conditioning can be switched on and off.

To create a switch for the air conditioning

- In the "Workspace Elements" window, search for the "Value" parameter in the "AirConditionManual" folder.

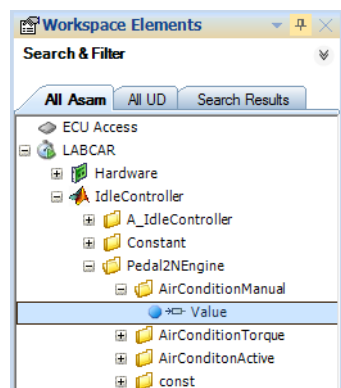

You can also create a control or display element as follows:

- Right-click the "Value" parameter.
- Select **Measure / Calibrate**.

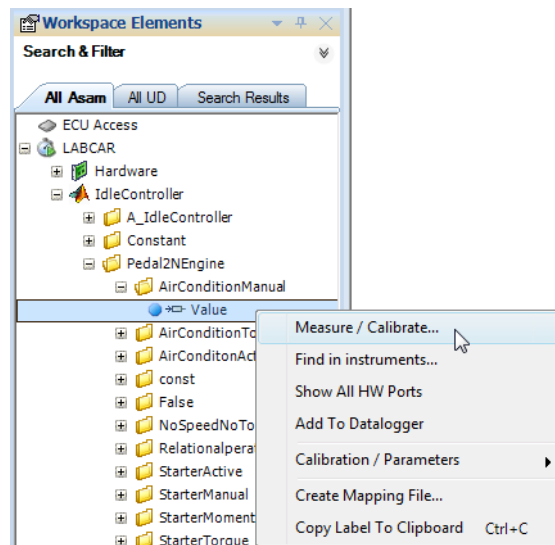

The "Create Instruments" window opens.

- Under "Instrument Type" select "On/Off".

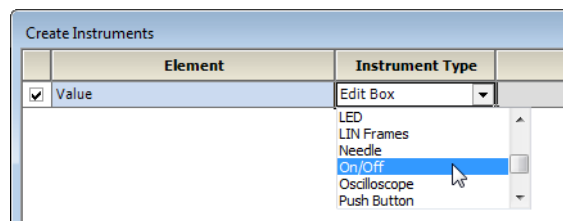

- Under "Group" select "<New Group>".
- Click **OK**.

The control element is created.

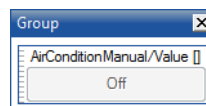

- Select the inner area of the control element and go into the "Properties" window.

- Under "Label Format", replace the character string "%Default" with "Air Condition".

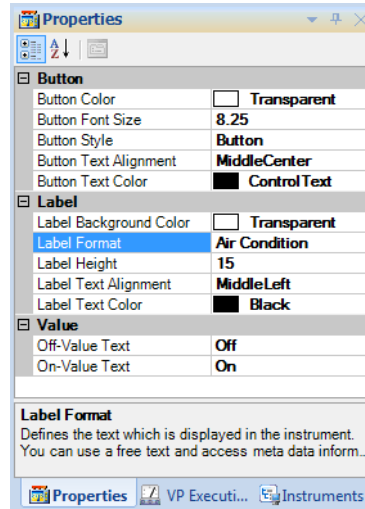

The switch now has the correct label.

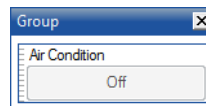

- Add the "Value" parameter to the oscilloscope.

To download an experiment to the target

- Make sure that the simulation target specified during project creation is connected and switched on.
- Select **Experiment** → **Download** → **LABCAR**.

or

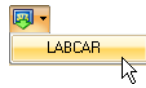

- Click the arrow next to the **Download** icon and select **LABCAR**.

The experiment is downloaded to the experimental target.

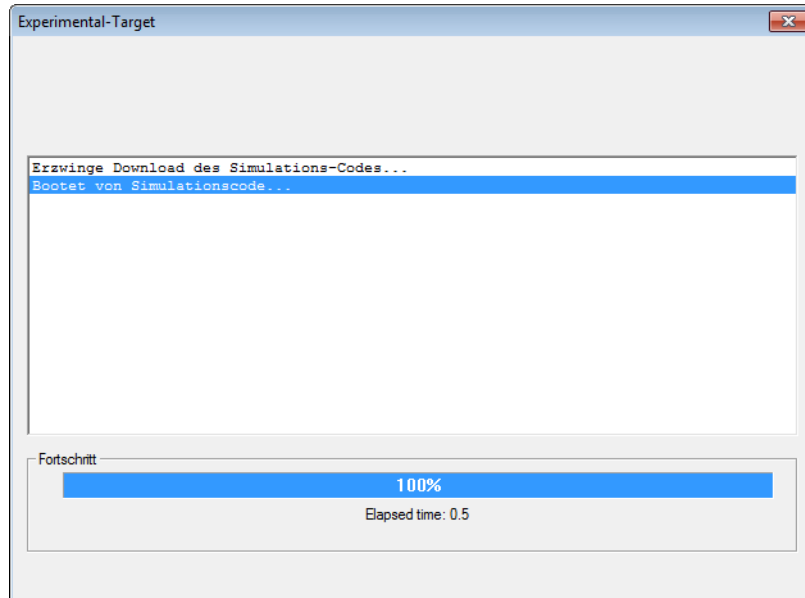

Successful downloading is indicated in the log window.

To run an experiment

- Launch the simulation with **Experiment** → **Start Simulation** → **LABCAR**.

or



- Click the arrow next to the **Start Simulation** icon and select **LABCAR**

The measure variable is displayed in the oscilloscope.

After a while, the idle speed stabilizes at 750 rpm.

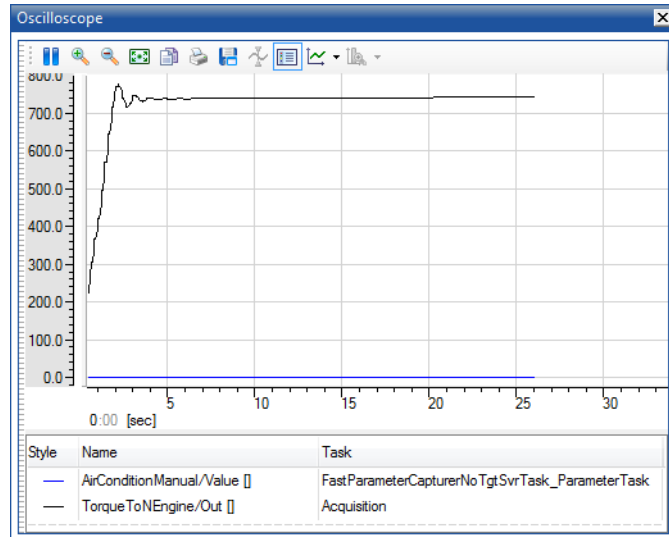

- To display the speed and the parameter for switching the air conditioning on and off each in their own coordinate system, right-click the coordinate system and select **Single Axis per Channel**.

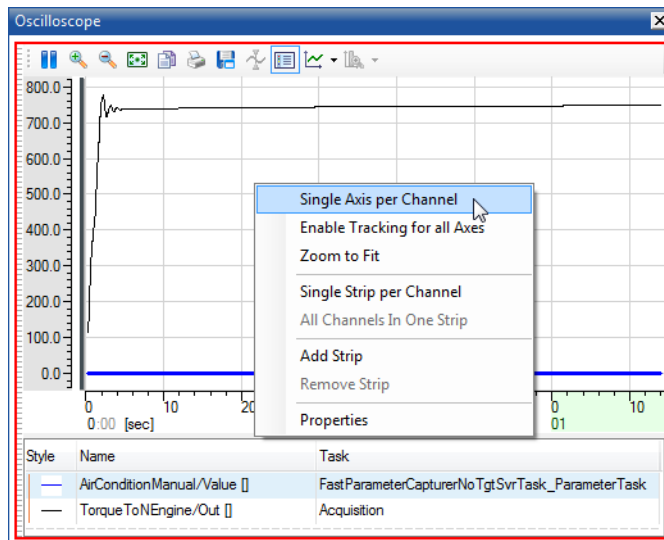

- To use the maximum necessary area for display for the relevant y axis, select the relevant axis.

- Right-click and select **Zoom to Fit**.

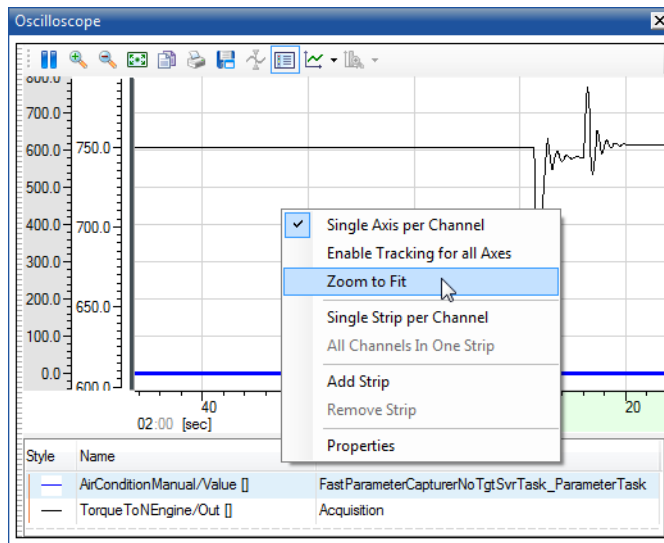

- If necessary, move the y axes using the mouse.
- Now switch on the air conditioning with the "Air Condition" switch created.
The idle speed briefly drops due to the additional torque and is then compensated by the idle controller.
- Switch the air conditioning back off.

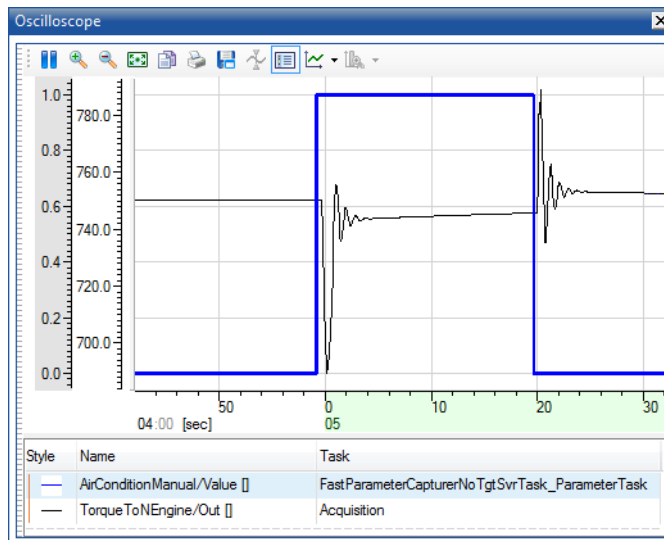

The pedal position corrected by the idle controller results in the speed briefly increasing; this is then also compensated.

- Stop the experiment by clicking the **Stop Simulation** icon.



or

- Select **Experiment** → **Stop Simulation** → **LABCAR**



- End the experiment by clicking the **Disconnect** icon.

or

- Select **Experiment** → **Disconnect** → **LABCAR**
- Select **File** → **Save Experiment**.
- Select **File** → **Exit**.

Return to LABCAR-IP to configure the hardware.

4.4 Configuring Hardware

The scope of this tutorial does not allow for creating a real HiL experiment – this section demonstrates how to work with the tools and use the functions of LABCAR-MCS in this sphere of implementation.

A/D converter hardware is used here (PB1651ADC1 A/D Module on an ES1651.1 Carrier Board) – this makes it possible to use a voltage signal between 0 and 10 V to switch the air conditioning on and off.

To create a hardware configuration

- Open LABCAR-IP
- Select **Project** → **RTIO Editor**.

or



- Click the **Edit Hardware Configuration** icon.

or

- Select the hardware module and select **Edit** from the shortcut menu.

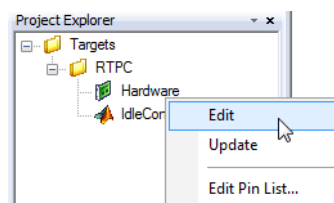

The RTIO Editor opens. The simulation target specified during project creation (here RTPC) is already in the HWC-Items tree.

- Select the "Domain" system below the simulation target "RTPC".

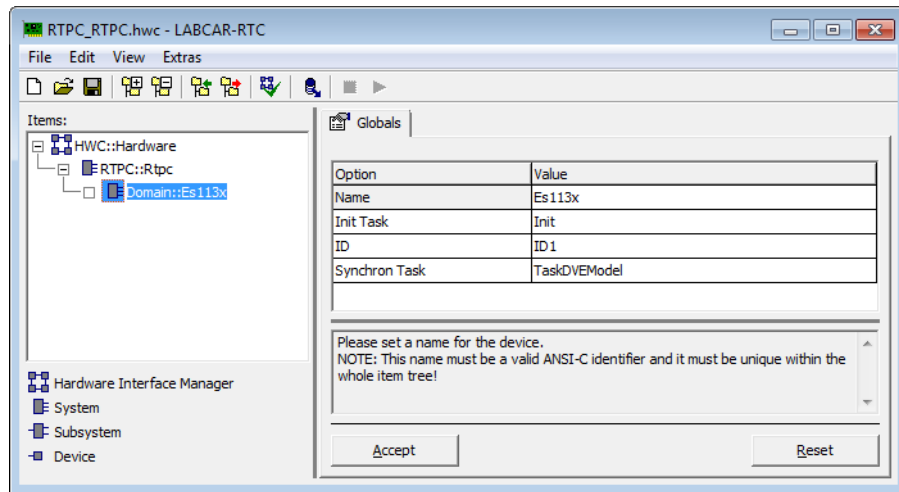

- Select **Edit** → **Add Item**.
The "Add Items" window opens.
- Select the item "ES1651-CB".

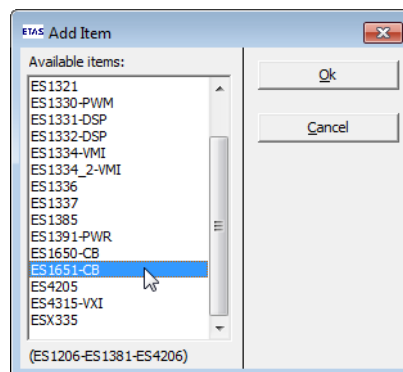

- Click **OK**.

The ES1651.1 Carrier Board is added to the hardware configuration.

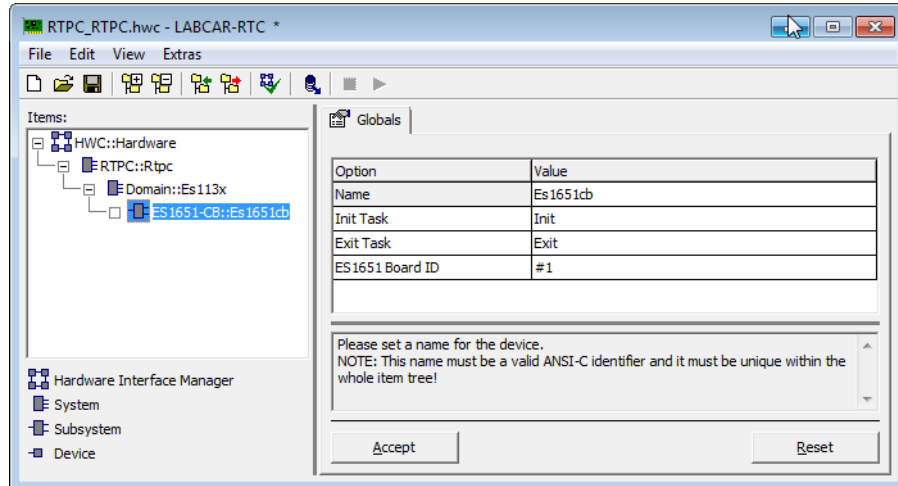

- Select this new item in the "Items" list.
- Reselect **Edit** → **Add Item**.
- In the "Add Items" window, select the item "PB1651ADC1".
- Click **OK**.

The PB1651ADC1.1 module is added to the hardware configuration.

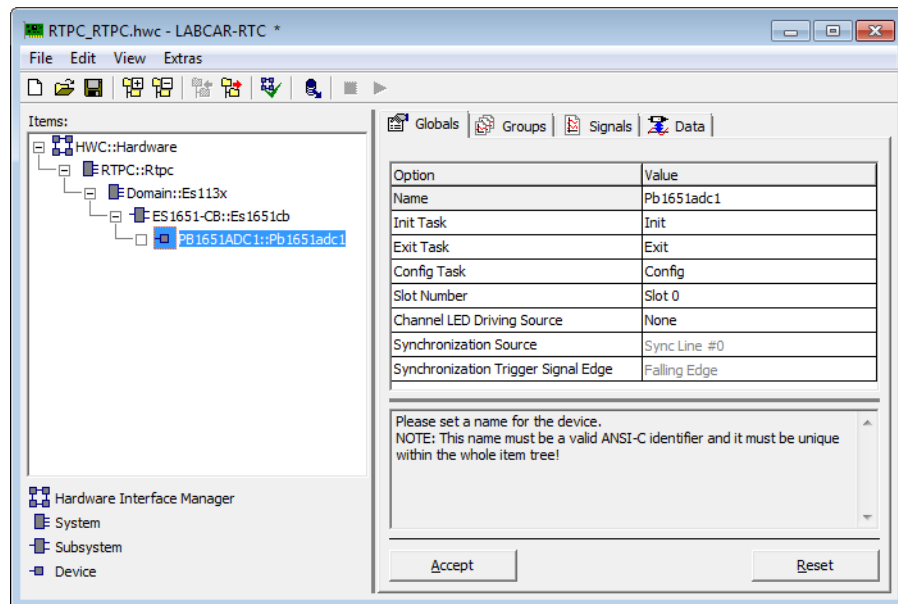

- Select the "Signals" tab.
- Select the signal "Analn_0".
- Double-click the cell under "Operating Mode".
- Select "Comparator" as operating mode.

- Double-click the cell under "Threshold [V]" .
- Enter 5.0 V.

This defines the channel as comparator – with voltages < 5 V the signal assumes the value "0", otherwise "1".

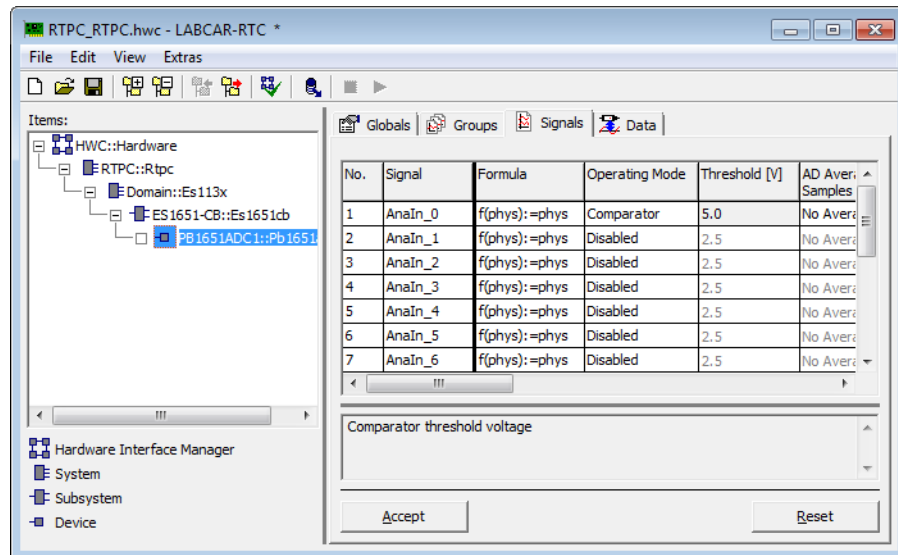

- Click **Accept**.
- Select **File** → **Save**.
- To close LABCAR-RTC select **File** → **Exit**.

4.5 Adding Inports

Before you can connect the hardware with model signals, you must add LABCAR inports or outports to the model.

To add an inport

- In the Project Explorer, select the "IdleController" model.
- In the shortcut menu, select **Edit**.

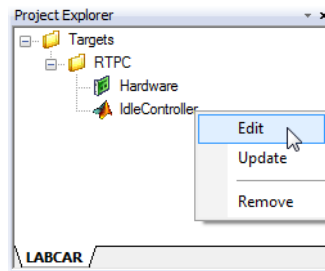

The model belonging to the project is opened in Simulink.

- If the "Pedal2Nengine" block has not been opened yet, double-click it.

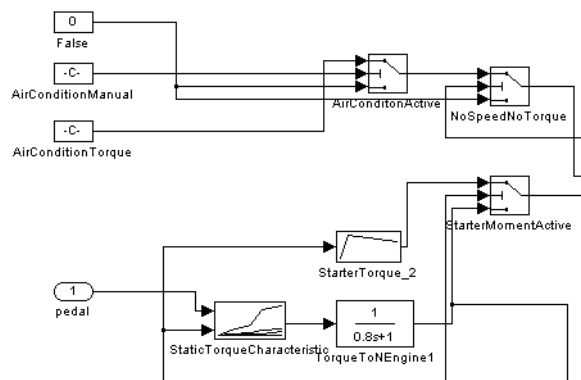

The "AirConditionManual" parameter is now to be supplied to the model using A/D converter hardware. For this to be possible, a LABCAR inport (instead of the constants) has to be added to the model for the relevant signal.

- In Simulink select **View** → **Library Browser**.
The Simulink Library Browser opens.
- Open the "LABCAR Port Blocks" library.

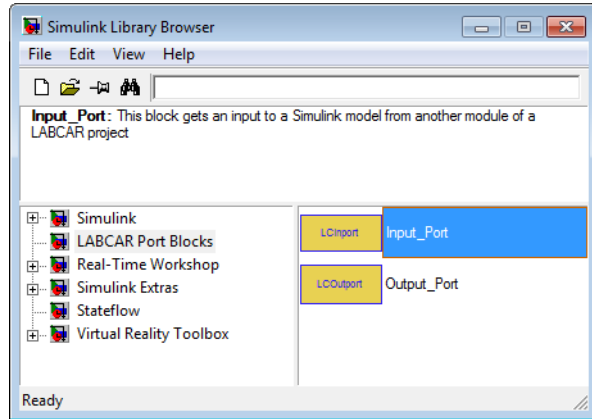

- Use the mouse to select an input port and drag it into the model.

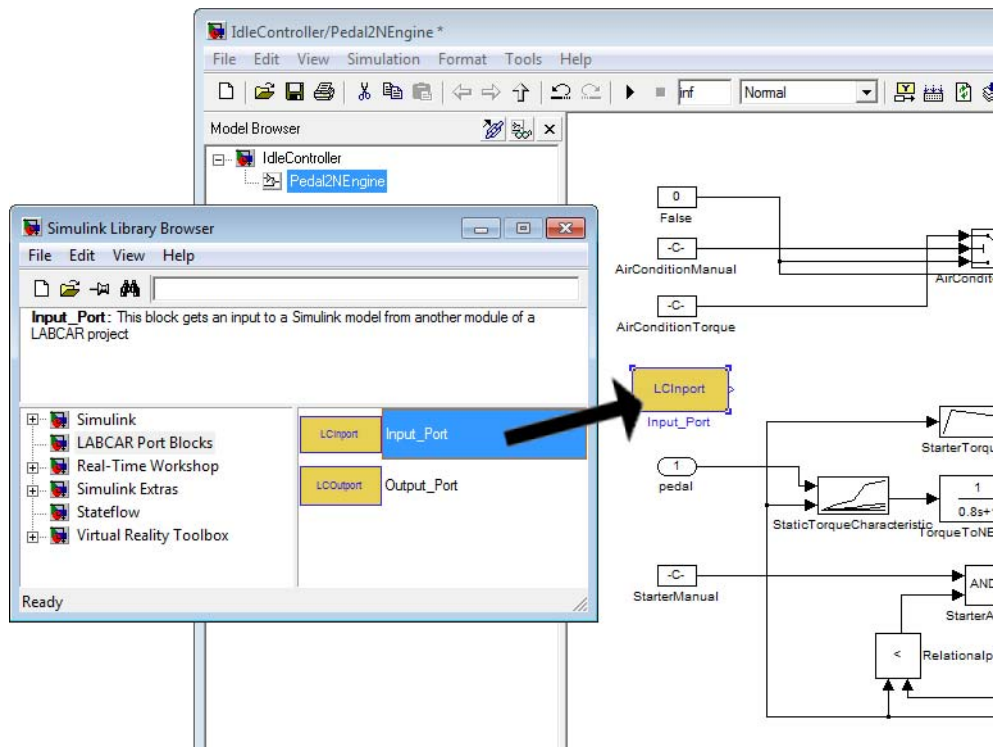

- Delete the "AirConditionManual" block.
- Rename the LABCAR import "AirConditionManual".

- Connect the LABCAR inport with the free input.

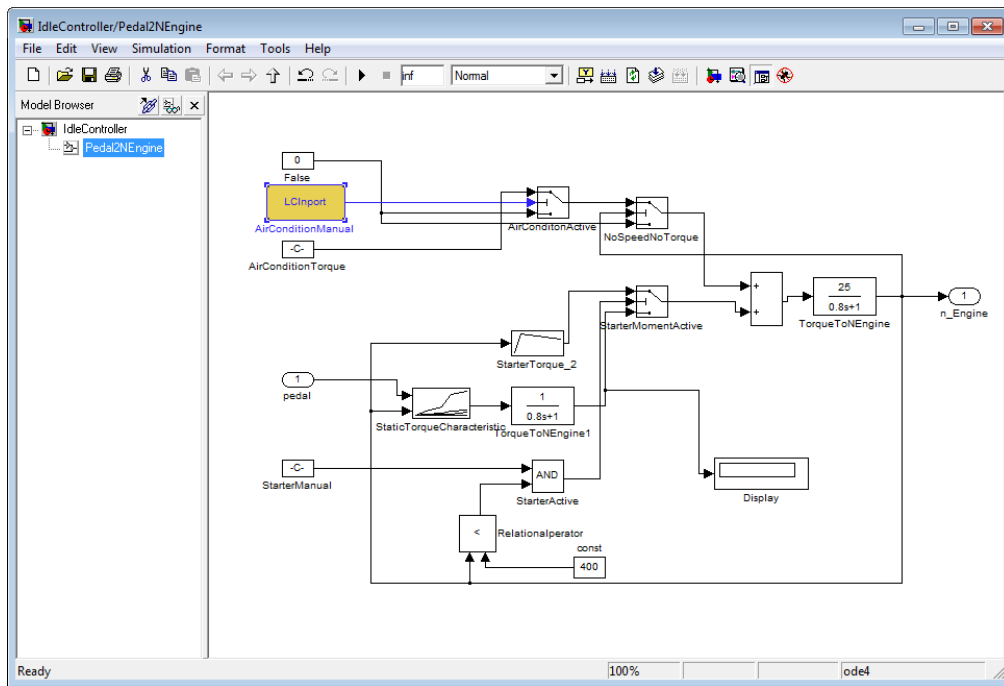

- Save the changes using **File** → **Save**.

4.6 Connecting Signals in the Connection Manager

The signal of the A/D converter ("0" or "1") is then connected to the model input "AirConditionManual" in the Connection Manager.

To launch the Connection Manager in LABCAR-OPERATOR

- Select the "Connection Manager" tab in the main window of LABCAR-OPERATOR V5.4.4.
The Connection Manager opens.
- Click **Update Ports** to update the display of all hardware and model ports.

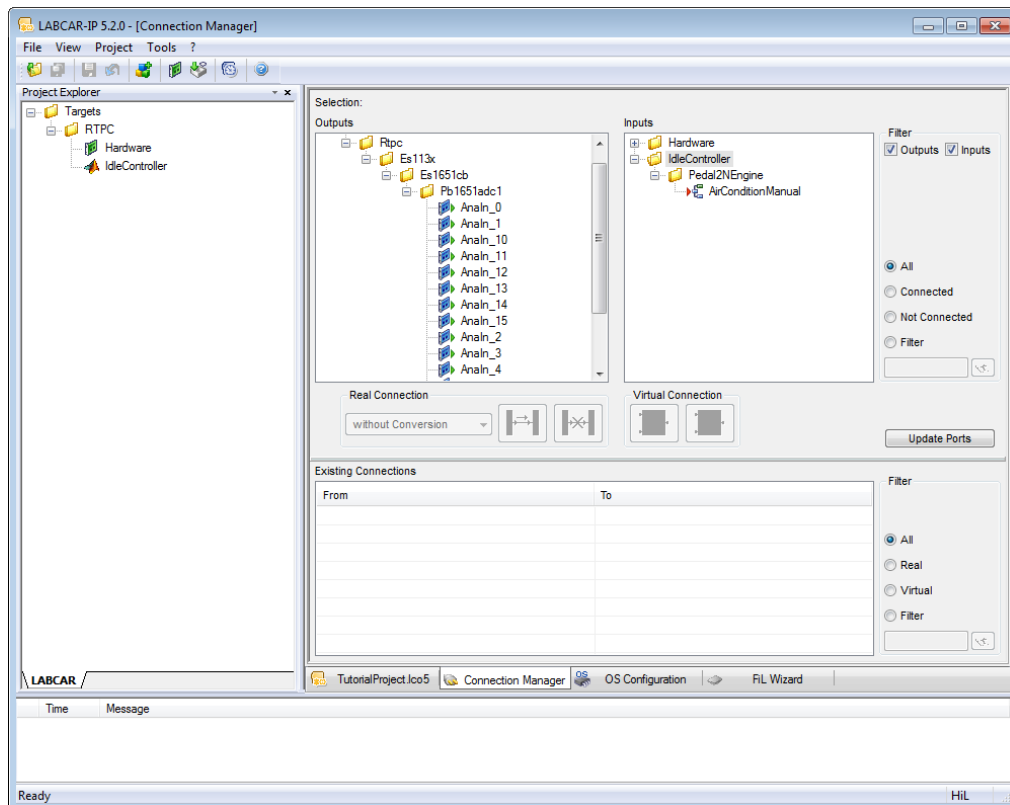

To create a connection between the model and the hardware

- Use the mouse to select the hardware output ("Analn_0") and the model input ("AirConditionManual").
- Click the icon to connect the selected signals.

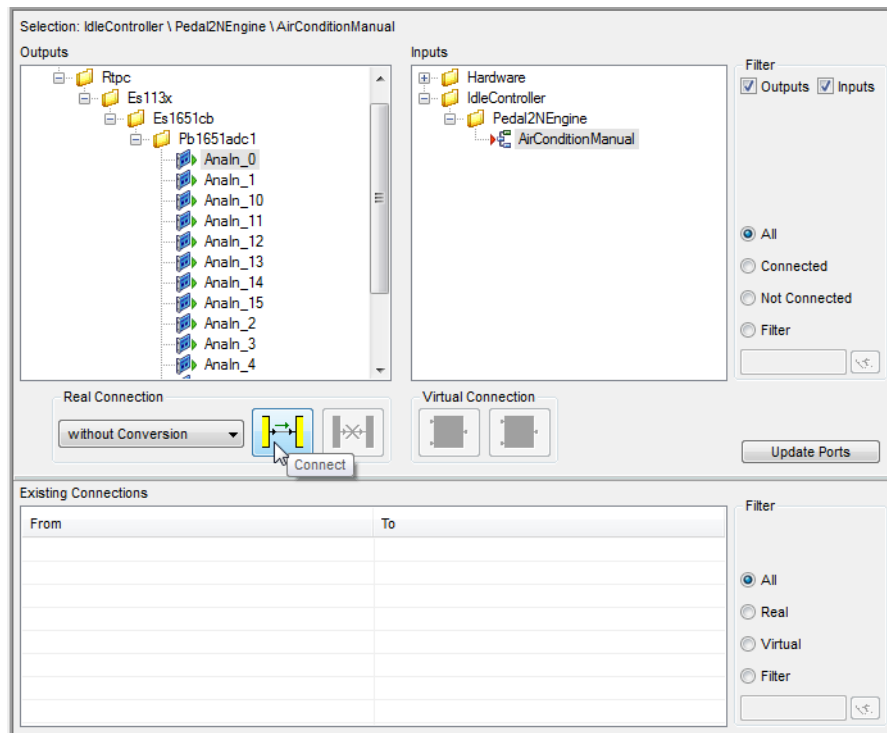

or

- Use the mouse to select an output and move it to the desired input.

The connection is created and shown in the field "Existing Connections" (providing no filter is active preventing newly created connections from being displayed).

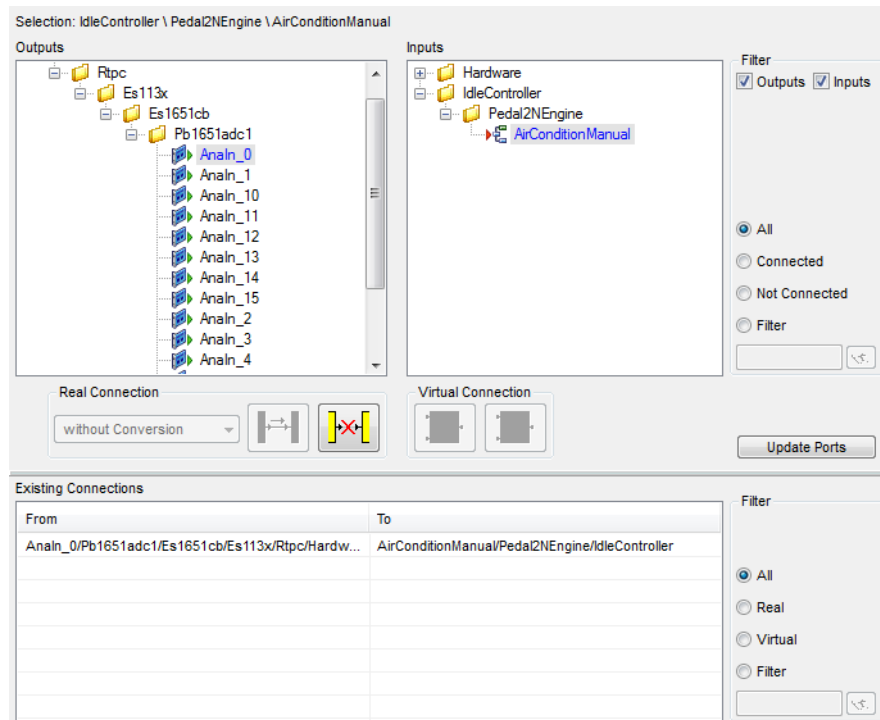

To indicate that this output has been connected to an input, the two ports are now shown in blue.

- Save the changes using **File** → **Save All**.

4.7 Configuration of the Real-Time Operating System

LABCAR-OPERATOR creates a standard OS configuration for every new project in which all the necessary tasks are available and all processes are assigned accordingly.

To familiarize yourself with the OS Configurator, open it as described below – a detailed description can be found in LABCAR-OPERATOR V5.4.4 - User's Guide.

To launch the OS Configurator

- Select the "OS Configuration" tab in the main window of LABCAR-IP.
The "OS Configuration" window opens.
- To be able to view all information, open all elements of both tree views and click the chevron button.

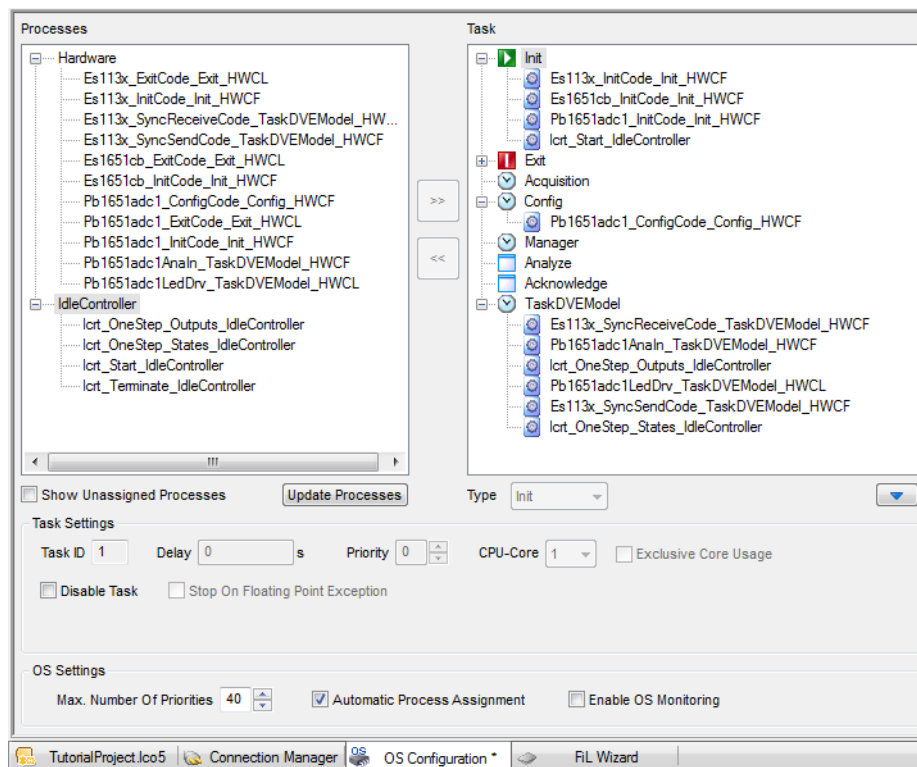

- Click **Update Processes**.
The "Processes" window (on the left) lists all hardware and model processes; the "Tasks" window shows all tasks created automatically and their assigned processes.
The automatic assignment can be accepted in this way.
- Save the changes using **File** → **Save**.

4.8 Running the Experiment

This section contains a description of the last steps you take before running the experiment.

The individual sections are:

1. "To generate code" on page 64
2. "To create a new layer for instrumentation" on page 65
3. "To display measure variables in the oscilloscope" on page 65
4. "To open a signal chain" on page 66
5. "To apply a voltage source to the ADC module" on page 68
6. "To start an experiment" on page 69

To generate code

- Make sure that the simulation target specified during project creation is connected and switched on.
- Select **Project** → **Build**.
- Select the modules to be created.

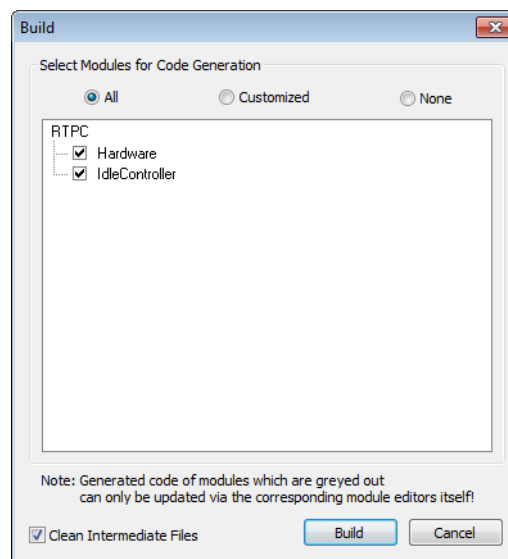

- Click **Build**.
Code generation for the model, the hardware configuration and the Connection Manager is started and an executable file generated.

- Use the "Messages" tab to make sure the build process was successful.

Time	Message
17:08:18	[BuildSystem]: Finishing subproject librtio.a
17:08:18	[BuildSystem]: Compiling connect.c
17:08:18	[BuildSystem]: Finishing subproject libconn.a
17:08:18	[BuildSystem]: Finishing subproject libmisc_code.a
17:08:18	[BuildSystem]: Finishing subproject libmisc_objects.a
17:08:22	[BuildSystem]: Finishing subproject RTPC.hex has already been created on the target...
17:08:22	[BuildSystem]: <Info>: Build finished.

If errors occur, a separate window containing detailed information opens.



- Click the **Experiment Environment** icon.
ETAS EE is launched and the experiment opened.

To create a new layer for instrumentation

The "Instrumentation" tab now contains the layer just created with the oscilloscope and the switch for the air conditioning. This switch is now highlighted which shows that the assigned parameter no longer exists (because it was replaced by a LABCAR inport).

- Click the name of the layer and select **Rename Layer**.
- Assign it, for example, the name "Experiment without hardware".
- Click in the tab environment and select **Create Layer**.

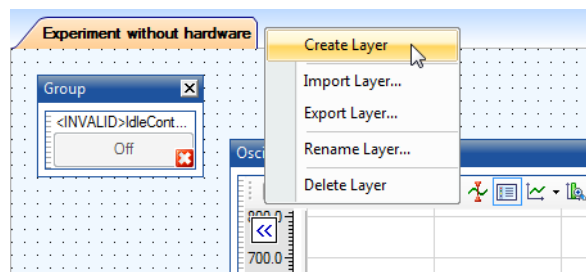

- Name the new layer, for example, "Experiment with hardware".

To display measure variables in the oscilloscope



- To create an oscilloscope for displaying the engine speed in the new layer, click the **Add Oscilloscope** icon in the toolbar.
- Add the measure variable for speed, "IdleController/Pedal2NEngine/TorqueToEngine/Out", by Drag&Drop.

- Also add the new model input "AirConditionManual".

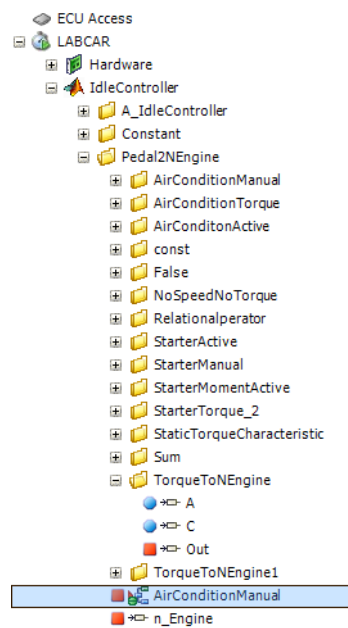

- Download the experiment to the simulation target.
- Start the simulation.

The idle speed reaches its default value and the value of "AirConditionManual" is "0" as there is no voltage at the hardware input and the D/A converter thus does not deliver an output signal.

Before using the I/O hardware, read the following section on the function of the "Signal List".

To open a signal chain

- In the Workspace Elements select the model input created previously, "AirConditionManual".
- Right-click and select **Signal** → **Trace**.

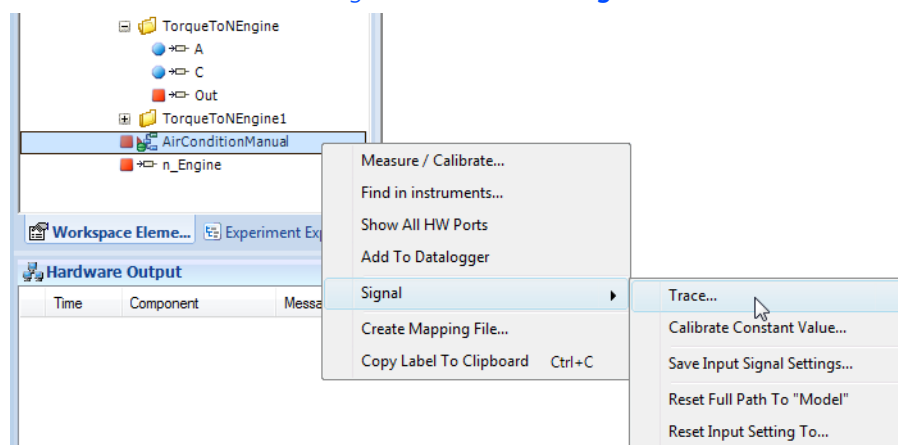

The "Select the Tracing Mode" window opens.

- Select "backward" and "<New Group>" and click **OK**.

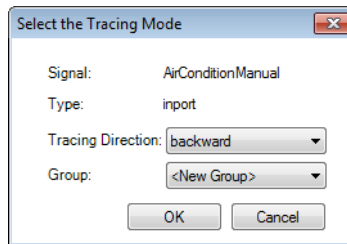

A new instrument of type "Signal List" opens.

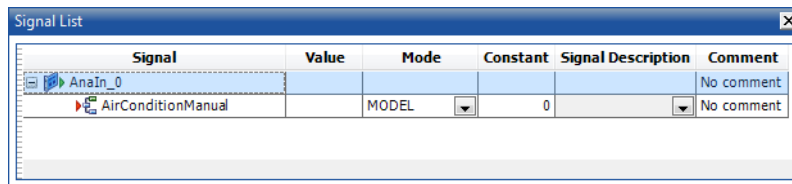

You can see the connection created previously in the Connection Manager between the A/D converter module and the model port.

- Select the inner section of the Signal List using the mouse.
- In the "Properties" window, change "Label Format" from "%HIERARCHY0" to "%HIERARCHY2".

This displays the full hierarchy of the signal names:

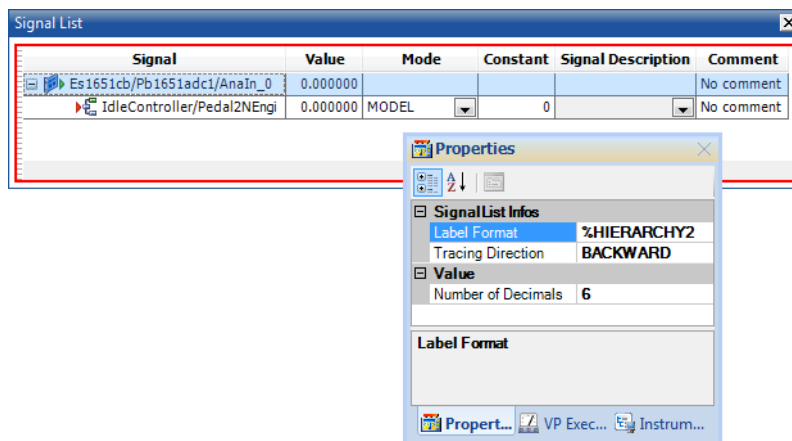

- To temporarily interrupt this connection, select "CONST" from the list in the "Mode" column.

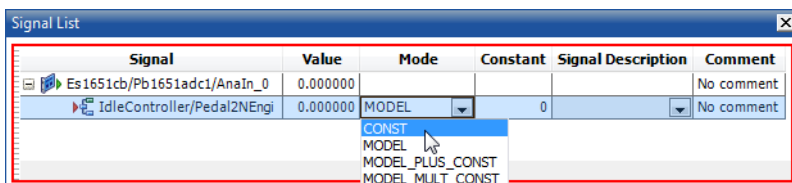

There is thus a constant value pending at this input which is specified in the "Constant" column.

- Start the simulation.
- Change the value in the "Constant" column to 1 (then press <Return>).

The idle speed again briefly drops and is compensated.

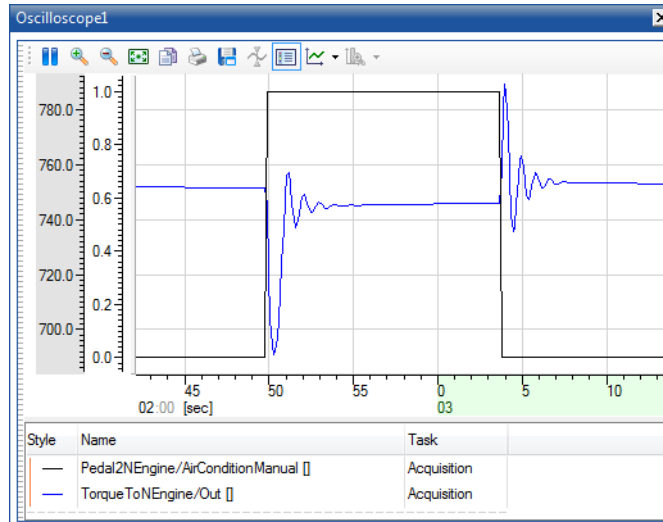

Signal	Value	Mode	Constant	Signal Description	Comment
Es1651cb/Pb1651adc1/AnaIn_0	0.000000				No comment
IdleController/Pedal2NEngi	0.000000	CONST	0		No comment

- Change the value in the "Constant" column back to "0" (then press <Return>).
- The idle speed behaves as normal and is compensated.
- Set "Mode" back to "MODEL" for the subsequent operation with hardware.

To apply a voltage source to the ADC module

- Connect a controllable voltage source (0 - max. 10 V) to the input channel 0. Consult the "PB1651ADC1 A/D Module – User's Guide" for information on the assignment of the front-facing connector.

To start an experiment

- Make sure that the simulation target specified during project creation is connected and switched on.
- Select **Experiment** → **Download** → **LABCAR**.

or



Click the arrow next to the **Download** icon and select **LABCAR**.

The experiment is downloaded to the experimental target.

Once this has been executed successfully, a message is output in the "Messages" tab.

- Select **Experiment** → **Start Simulation** → **LABCAR**.

or



- Click the arrow next to the **Start Simulation** icon and select **LABCAR**.

The experiment is launched.

As long as the applied voltage is under the pre-defined threshold, the "AirConditionManual" signal equals 0, the idle speed has the default value 750 rpm.

"0" is also displayed as the value in the Signal List.

Signal	Value	Mode	Constant	Signal Description	Comment
Es1651cb/Pb1651adcl/AnaIn_0	0.000000				No comment
IdleController/Pedal2NEngi	0.000000	MODEL	0		No comment

- Now modify the voltage so that it is greater than the comparator threshold of 5.0 V.
The air conditioning is switched on ("AirConditionManual" = 1), the idle speed briefly drops due to the additional torque and is then compensated.
- Lower the voltage so that it is once again below the comparator threshold of 5.0 V.
After an overshoot, the idle speed is adjusted.



- Stop the experiment by clicking the **Stop Simulation** icon.

or

- Select **Experiment** → **Stop Simulation** → **LABCAR**.

4.9 Recording with the Datalogger

This section contains instructions on how to record signals with the Datalogger. To record the air conditioning being switched on and off with the Datalogger, proceed as follows:

To create a Datalogger

- In the ETAS EE workspace, select the "Datalogger" tab.

The screenshot shows the 'Datalogger Configuration' window with a sidebar on the left containing tabs for 'Instrumentation', 'Datalogger', 'Signal Generator', and 'RT-Plugins'. The main area is divided into several sections:

- Datalogger Configuration:** Contains 'Load', 'Save', and 'Save As' buttons.
- Available Dataloggers:** A table with columns 'Name', 'Active', 'State', and 'Rec. Time'. It is currently empty with the text 'No Datalogger Selected' below it. 'Add' and 'Remove' buttons are on the right.
- Signals to record:** A table with columns 'Name', 'Task', and 'Indices'. It is currently empty. 'Remove' and 'Remove All' buttons are on the right.
- Recording File Settings:** Includes a 'Recording base filename' field, an 'Auto Increment' checkbox, a 'Digits' spinner set to 4, and a 'Final recording filename(s) preview' field.
- Trigger Settings:** Shows a timeline with 'START' and 'STOP' markers. It includes 'Pre Trigger Time' (0 s), 'Post Trigger Time' (0 s (0 = endless)), and fields for 'Start Trigger' and 'Stop Trigger' with associated 'Condition' fields and dropdown menus.

- Click **Add** in the "Available Dataloggers" field. A new Datalogger is added

This close-up shows the 'Available Dataloggers' table after a new entry has been added:

Name	Active	State	Rec. Time
New Datalogger 1	<input type="checkbox"/>	Off	-

'Add' and 'Remove' buttons are visible to the right of the table.

To configure the Datalogger

- To add a signal to the Datalogger from the Element List, select "Out" (see figure).
- Press the left-hand mouse button and drag the element to the "Signals to record" area.

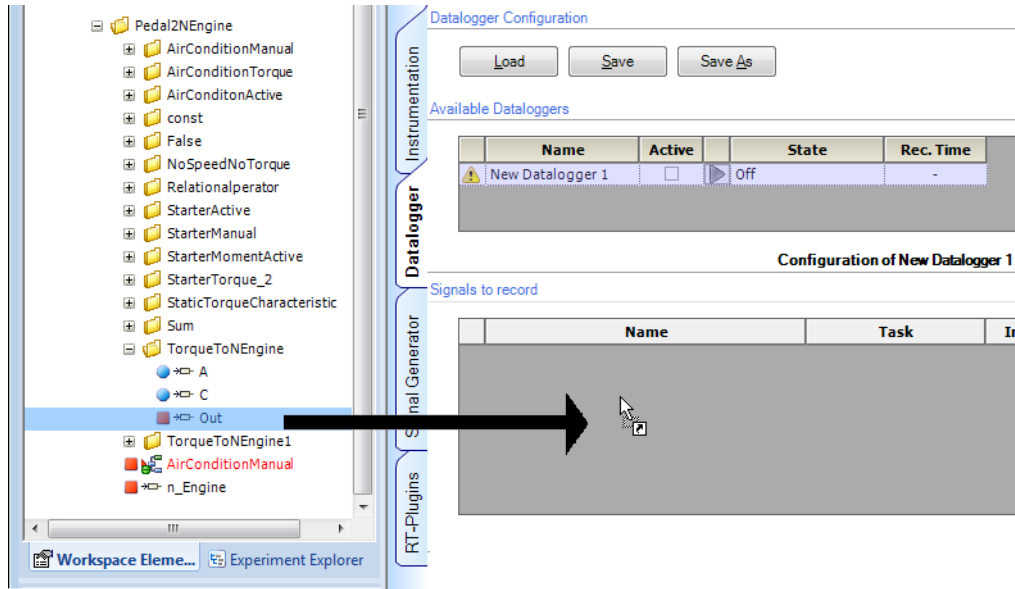

The signal is added to the list of signals to be recorded.

- Also add the "AirConditionManual" model input to the Datalogger.

Signals to record

	Name	Task	Indices
✓	IdleController/Pedal2NEngine/AirConditionManual	Acquisition	-
✓	IdleController/Pedal2NEngine/TorqueToNEngine/Out	Acquisition	-

- Select a task according to which the Datalogger should record (here "Acquisition").

To select a file for the recorded data

The "base name" for the file in which the recorded data is to be stored is specified in the "Recording File Settings" field under "Recording base file-name".

- To select a different base file, click
The name of the file created after every recording is determined by the option selected under "Auto Increment".

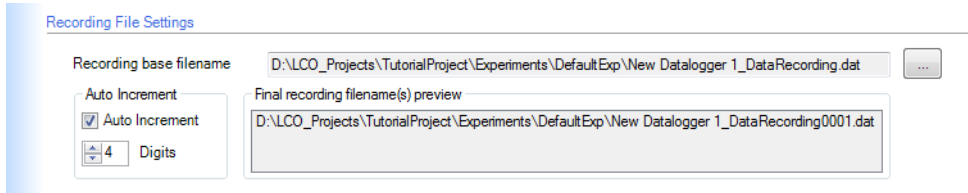

Selecting the "Auto Increment" option results in the file name being extended by a number which is incremented automatically each time the Datalogger starts. Specify the number of digits of this number in the "Digits" field.

To start the Datalogger manually

- Start the simulation.

Note

The Datalogger can only be activated when the simulation is running!

- Activate the Datalogger (in the "Active" column).

Datalogger Configuration

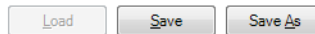

Available Dataloggers

	Name	Active	State	Rec. Time
✓	New Datalogger 1	<input checked="" type="checkbox"/>	▶ WaitingForTrigger	-

- To start the Datalogger click the blue arrow head.

Datalogger Configuration

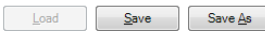

Available Dataloggers

	Name	Active	State	Rec. Time
✓	New Datalogger 1	<input checked="" type="checkbox"/>	▶ WaitingForTrigger	-

The Datalogger is started.

- To stop the Datalogger click the blue square.

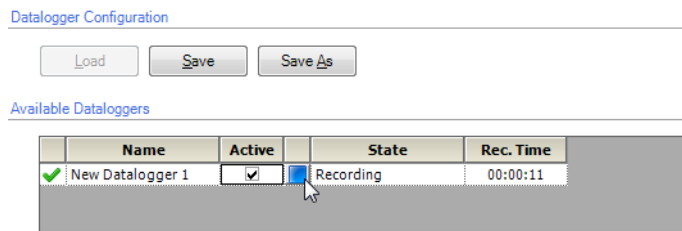

The Datalogger is stopped and the data stored in a file (*.dat).

To define the trigger conditions and recording duration

If you want the recording to start (or end) automatically, you must define a trigger condition.

- Click the ... icon at the bottom right of the "Trigger Settings" field.

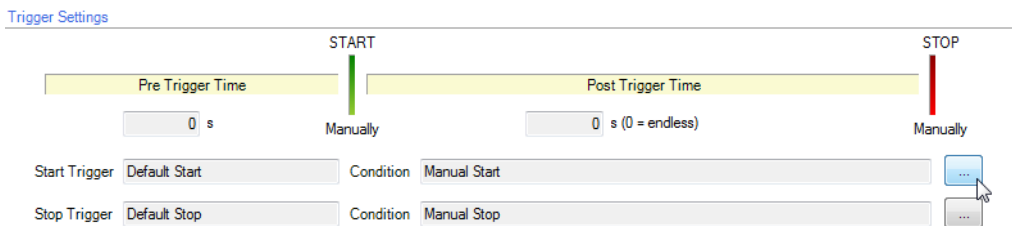

The editor for trigger settings opens.

- Under "Filter Type", select "Start Trigger Filter"

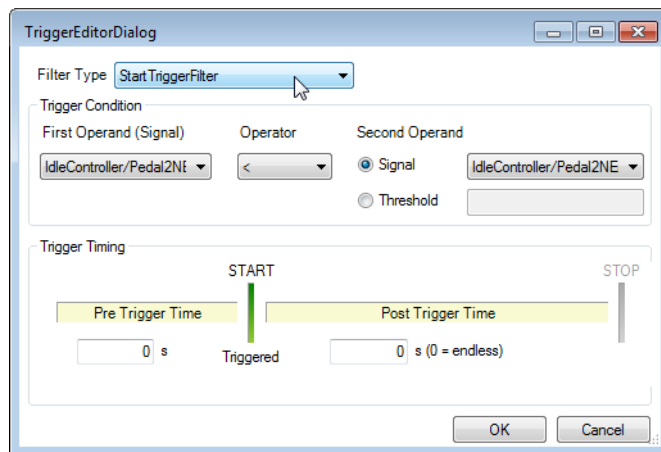

- Select the following settings under "Trigger Condition":
 - First Operand (Signal): "AirConditionManual"
 - Operator: >
 - Threshold: 0.5

- Under "Trigger Timing" select the following settings:
 - Pre Trigger Time: 0 s
 - Post Trigger Time: 10 s

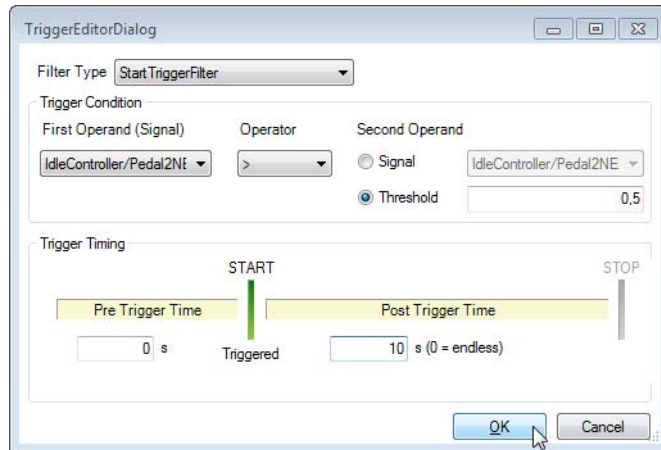

- Click **OK**.
- Activate the Datalogger (in the "Active" column).

Datalogger Configuration

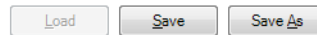

Available Dataloggers

	Name	Active	State	Rec. Time
✓	New Datalogger 1	<input checked="" type="checkbox"/>	▶ WaitingForTrigger	-

- Now switch on the air conditioning with your voltage source.

The Datalogger starts recording data once the trigger condition occurs and stops doing so 10 s later.

Datalogger Configuration

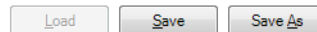

Available Dataloggers

	Name	Active	State	Rec. Time
✓	New Datalogger 1	<input checked="" type="checkbox"/>	■ Recording	9,1

5 ETAS Network Manager

The ETAS Network Manager is used for creating a configuration that will be used by the ETAS IP Manager. The IP Manager is responsible for dynamic IP addressing of the ETAS hardware used in your network (ETAS network).

5.1 Overview

ETAS software supports different configurations for hardware access via Ethernet:

- Using multiple network adapters:
 - one network adapter for the company network,
 - one or more network adapters for the ETAS hardware.
- Using one network adapter
 - automatic toggling between the company network and the ETAS hardware.

Note

You do not require a separate network adapter to connect the ETAS hardware to your PC. You can use the same network adapter both for the company network and the ETAS network.

The ETAS Network Manager supports you in selecting the network adapter for the ETAS hardware.

The ETAS Network Manager gives you an overview of the network adapters available for your PC and the type of IP address assignment. If more than one network adapter is available in the system, you can select the network adapter to use for connecting the ETAS hardware to your PC. You can also specify the address range for the IP assignment for the ETAS hardware.

You do not need administrator rights to select the network adapter and the network environment configuration for the ETAS hardware. You can toggle between the ETAS network and the company network without rebooting your PC.

Note

With the ETAS Network Manager, you cannot create or modify the configuration for the network adapter. Instead modify the network settings of your PC via the Control Panel (see the documentation for your operating system). Please note that this requires administrator rights.

5.2 ETAS Hardware Addressing

You can connect several ETAS devices (including those that are the same type) to your PC. The connected devices are identified in the local ETAS network by their unique IP address.

An IP Manager integrated in the ETAS software looks up which IP addresses are available in a pre-configured address pool and assigns available IP addresses to the connected ETAS hardware.

The address range for the address pool is specified using the ETAS Network Manager.

5.3 Network Adapter Addressing

5.3.1 Type of Network Adapter Addressing

The type of network adapter addressing done within the company network depends on the operating system being used and the network adapter configuration:

Operating System	Type of Network Adapter Addressing			
	Manual	DHCP	DHCP+APIPA	DHCP+ alternative IP address
Windows 7	yes	yes	yes	yes
Windows 10	yes	yes	yes	yes

The ETAS network supports the following types of network adapter addressing:

Operating System	Type of Network Adapter Addressing			
	Manual	DHCP	DHCP+APIPA	DHCP+ alternative IP address
Windows 7	yes	no	yes	yes
Windows 10	yes	no	yes	yes

If you wish to use the network adapters both for the company network and the ETAS network, you cannot use the network adapters that exclusively support DHCP addressing for this dual operation.

Note

DHCP can be used only in combination with APIPA or an alternative IP address!

5.3.2 Addressing the Network Adapter Manually

Addressing a network adapter depends on the operating system.

For instructions on addressing your PC’s network adapter, see the documentation for your operating system.

To address the network adapter manually, you need administrator rights. Please contact your system administrator, if necessary.

If the network adapter is addressed manually, i.e., it has a static IP address, it may happen that you accidentally end up searching for or initialize ETAS hardware, although the PC is connected to the company network. The Network Manager allows you to stipulate that if this happens, you are to receive a warning before an IP address is assigned to an ETAS hardware.

5.3.3 Addressing the Network Adapter via DHCP

Addressing via DHCP requires that the DHCP server be available. Should the DHCP server not be available, or if there is no DHCP server (as in the ETAS network), the network adapter has not been configured.

In this instance, each operating system has a feature that automatically assigns the network adapter an IP address:

Windows XP / Windows Vista / Windows 7

Windows XP, Windows Vista and Windows 7 automatically check whether there is a connection to the DHCP server. If there is none, it either assigns the IP address automatically via APIPA, or it uses the user-specified alternative IP address. The ETAS network always uses either the APIPA address or the alternative IP address.

When toggling between the DHCP network and ETAS hardware, make sure that the operating system is able to detect a connection failure because only then will reconfiguration be initiated. This may take up to 10 seconds. It takes the operating system 60 seconds to entirely reconfigure from a DHCP address to an APIPA address or to the alternative address. If the network adapter is once again connected to the DHCP network, configuring to a DHCP address takes place right after the connection has been detected.

Addressing a network adapter via DHCP without alternative addressing is not supported.

5.4 User Interface

5.4.1 Configuration Dialog Window 1 — Selection of Network Adapter ("Network settings for ETAS hardware (page 1)")

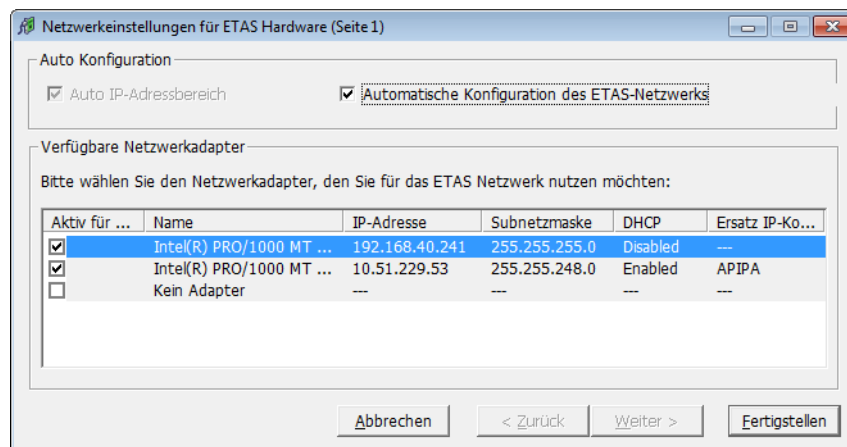

The following information on the available network adapters is displayed:

- **Auto IP Address Range** checkbox

If you tick this checkbox, the next configuration step is skipped, and the ETAS Network Manager automatically assigns default IP address ranges that will be used by the selected network adapter for addressing the ETAS hardware. If the IP address range is automatically changed by the IP Manager, a message is displayed in the system tray.

- **Auto Configure ETAS Network** checkbox

If you tick this checkbox, you can enable or disable several network adapters at once for auto-configuration through the IP Manager.

When you tick the checkbox, the "Auto IP Address Range" checkbox is activated. In the list of available network adapters, the "Active for ETAS Network" column is inserted, where you can determine which network adapters shall be available for auto-configuration through the ETAS Network Manager.

The ETAS Network Manager will go through the list (top-down) and use the first adapter which has a valid IP configuration for ETAS¹ and configure the IP address range automatically. If a configured network adapter fails, e.g. because the network adapter is being disabled or physically not available, the IP Manager will configure the next available network adapter automatically, and a message is displayed in the system tray, indicating the new configuration.
- **Active for ETAS Network** column

This column is only visible if the "Auto Configure ETAS network" checkbox is ticked. In the checkbox in this column you can determine which network adapters shall be enabled for autoconfiguration by the ETAS Network Manager (siehe „Auto-Configuring Network Adapter for ETAS Hardware“ auf Seite 83).
- **Name** column

Name of the network adapter. This entry cannot be edited in this window.

This column also contains an entry with the name "No Adapter". If you want to disable the IP Manager, e.g. because there is no Ethernet hardware connected to the PC, you can tick this entry in the "Active for ETAS Network" column.
- **IP Address** column

IP address of the network adapter. This entry cannot be edited in this window.
- **Subnet Mask** column

Setting for the subnet mask. This entry cannot be edited in this window.
- **DHCP** column

Shows whether the network adapter is configured for DHCP:

 - Enabled
The network adapter is configured for DHCP.
 - Disabled
The network adapter is configured with a fixed IP address.
- **Alternate IP Configuration** column

Shows the alternative IP address of the network adapter if it is configured for DHCP. This indication depends on the operating system being used.

¹. An IP configuration is valid if the network adapter either uses a fix IP address, or if DHCP and APIPA are enabled.

- APIPA
Automatic Private IP Addressing: method for automating the IP configuration for network connections
- ---
An alternative IP address does not exist.
- User defined
The user can define a user-specific alternative IP address.

5.4.2 Configuration Dialog Window 2 — Defining the Address Pool ("Network settings for ETAS hardware (page 2)")

In general, all values can be modified by directly typing them in the corresponding field, or by selecting the default setting from a list box.

The following network parameters can be set:

- **Start Address**
The first IP address in the IP address range for the ETAS hardware
- **End Address**
The last IP address in the IP address range for the ETAS hardware
- **Subnet Mask**
Associated Subnet Mask

Reserved IP Addresses

The following IP addresses are reserved for certain ETAS hardware in the IP address range that the ETAS hardware (192.168.40.1 - 192.168.40.254 with Subnet Mask 255.255.255.0) is currently using:

IP_Address	ETAS Hardware
192.168.40.10	ES1120
192.168.40.11	ES1130
192.168.40.12	ES780

IP_Address	ETAS Hardware
192.168.40.13	Reserved
192.168.40.14	ETAS Real-Time PC
192.168.40.15	ES1135

These addresses are assigned exclusively to these devices and thus may not be used for other ETAS hardware. This has to be taken into consideration when defining the address pool.

5.4.3 Configuration Dialog Window 4 — Displaying Warning ("Network settings for ETAS hardware (Page 4)")

This dialog window appears only if the selected network adapter is addressed manually.

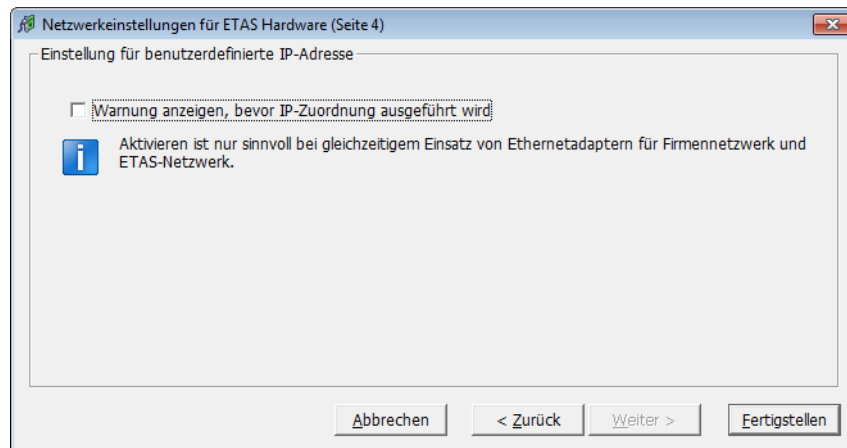

The following parameters can be set:

- **Display warning before IP address assignment is executed**
Use this checkbox to specify that a warning be displayed before an IP address is assigned to an ETAS hardware device.

Note

Enabling this warning is useful only if you want to run the PC both in the company network or on an ETAS measurement module in the ETAS network using this network adapter.

5.5 Configuring Network Addresses for ETAS Hardware

5.5.1 Manually configuring the Network Adapter

To configure the network adapter for ETAS hardware:

1. In the Windows Start menu, go into the program folder of your ETAS software (below **Start** → **Programs** → **ETAS**), and select **ETAS Network Settings**.

The "Network settings for ETAS hardware (Page 1)" dialog window is opened.

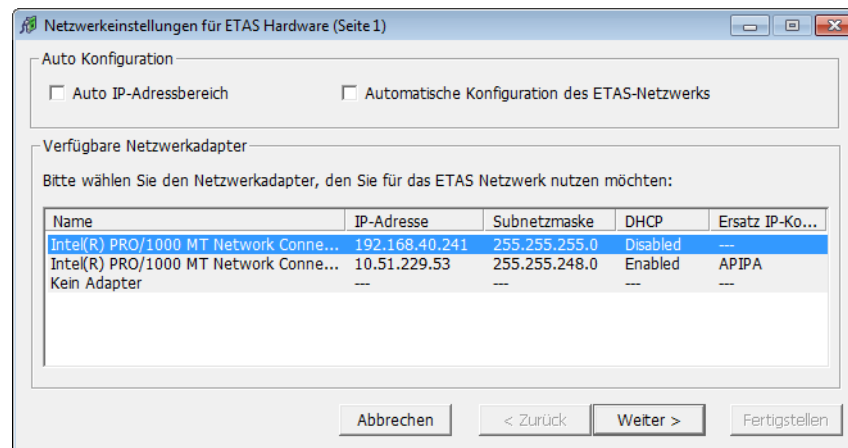

2. In the "Available Network Adapters" area, select the network adapter you want to use for the corporate network and the ETAS network. If no network adapter is installed on the PC, the dialog window contains no entries.

Note

The type of addressing of the network adapter must be supported by the ETAS network. Otherwise, you cannot select the network adapter.

3. Click **Continue**.

The "Network settings for ETAS hardware (Page 2)" dialog window opens.

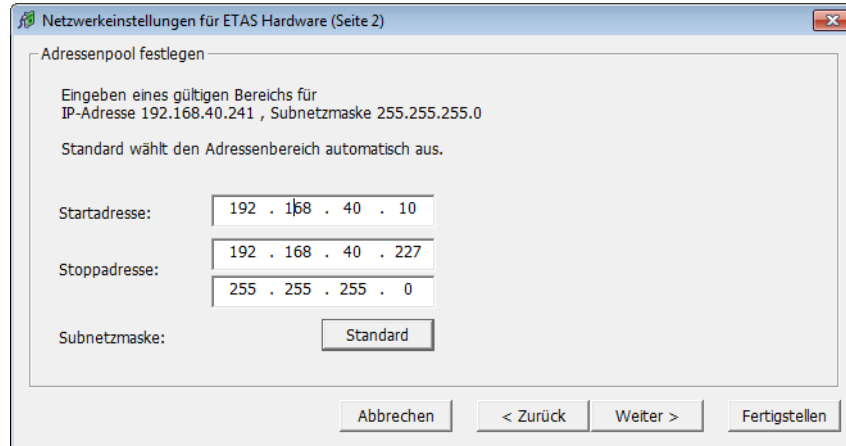

4. Enter the IP address range for the ETAS hardware and the subnet mask, or click **Default** to have the Network Manager automatically complete the IP address range and the subnet mask.

You may accept these settings or overwrite them.

5. Click **Continue**.

The "Network settings for ETAS Hardware (Page 4)" dialog window opens.

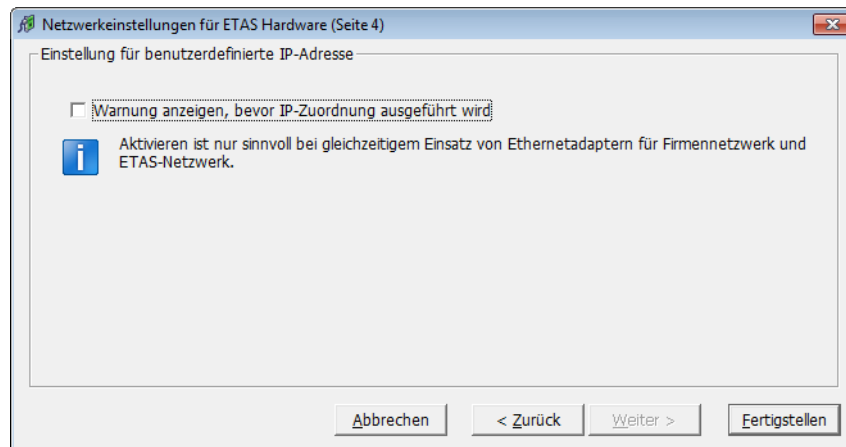

6. If you want to define that a warning is displayed before the ETAS hardware is assigned an IP address, enable "Display warning before IP address assignment is executed".

Note

Enabling this warning is useful only if you want to run the PC both in the company network or on an ETAS measurement module in the ETAS network using this network adapter.

7. Click **Finish**.
8. Restart the ETAS software to make the changes become effective. If the Network Manager was started automatically during a hardware search or initialization, you do not have to restart the ETAS software to apply the changes.

5.5.2 Auto-Configuring Network Adapter for ETAS Hardware

The ETAS Network Manager offers the automatic assignment of IP address ranges in the ETAS network through the IP Manager. You can either use auto-configuration of a selected network adapter, or, if more than one network adapter is available, let the IP Manager auto-configure the ETAS network, including the selection of the adapter to be used.

How to auto-configure a selected network adapter for ETAS hardware

1. In the Windows Start menu, go into the program folder of your ETAS software (below **Start** → **Programs** → **ETAS**), and select **ETAS Network Settings**.

The "Network settings for ETAS hardware (Page 1)" dialog window is opened.

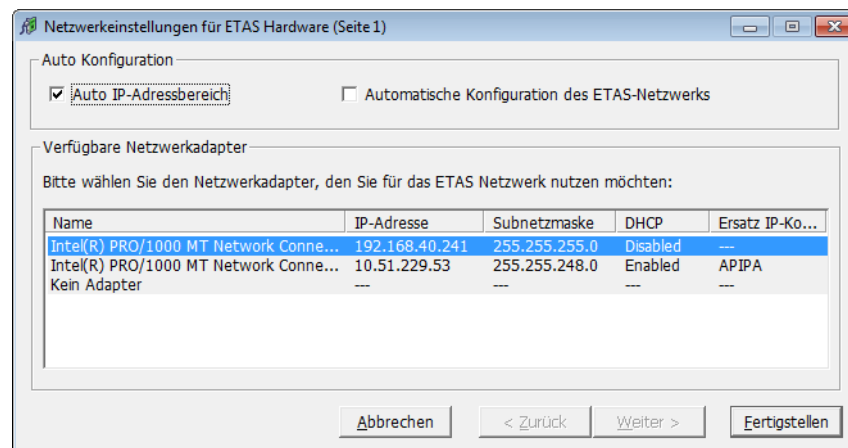

2. In the "Available Network Adapters" area of the "Network settings for ETAS hardware (Page 1)" dialog window, select the network adapter you want to use for the corporate network and the ETAS network. If no network adapter is installed on the PC, the dialog window contains no entries.

Note

The type of addressing of the network adapter must be supported by the ETAS network. Otherwise, you cannot select the network adapter.

3. Tick the "Auto IP Address Range" checkbox.

4. Click **Finish**.

The ETAS Network Manager automatically assigns default IP address ranges that will be used by the selected network adapter for addressing the ETAS hardware.

If later on, the IP address range is automatically changed by the IP Manager, a message is displayed in the system tray.

How to auto-configure a network adapter, with multiple network adapters being available

1. In the Windows Start menu, go into the program folder of your ETAS software (below **Start** → **Programs** → **ETAS**), and select **ETAS Network Settings**.

The "Network settings for ETAS hardware (Page 1)" dialog window is opened.

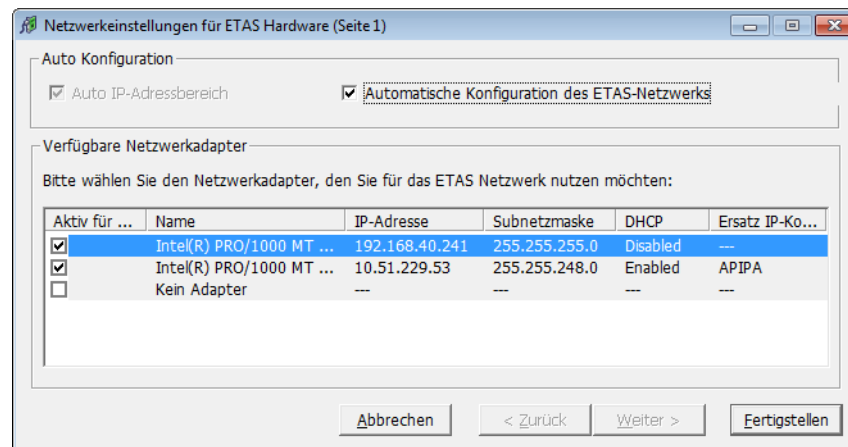

2. In the "Network settings for ETAS hardware (Page 1)" dialog window, tick the "Auto Configure ETAS Network" checkbox.

The "Auto IP Address Range" checkbox is activated, and in the list of available network adapters, the "Active for ETAS Network" column is inserted.

3. Enable all network adapters that shall be available for auto-configuration through the IP Manager by ticking the corresponding checkbox in the "Active for ETAS Network" column.

4. Click **Finish**.

Starting with the network adapter that is currently selected in the dialog window, the ETAS Network Manager will go through the list (top-down), and use the first adapter which has a valid¹ IP configuration for ETAS and configure the IP address range automatically. If a configured network adapter fails, e.g.

¹ An IP configuration is valid if the network adapter either uses a fix IP address, or if DHCP and APIPA are enabled.

because the network adapter is being disabled or physically not available, the IP Manager will configure the next available network adapter automatically, and a message is displayed in the system tray, indicating the new configuration.

5.5.3 Enabling APIPA in the Registry

Note

You need administrator rights to make changes in the Registry.

To enable APIPA in the Registry:

1. Click **Start**, and then click **Run**.
2. Enter `regedit`, and click **OK**.
The Registry editor opens.
3. Click the entry for a network adapter in the Registry key:

Global key (refers to all network adapters)

```
HKEY_LOCAL_MACHINE\SYSTEM\  
CurrentControlSet\  
Services\Tcpip\Parameters
```

Interface or card-specific key

```
HKEY_LOCAL_MACHINE\SYSTEM\  
CurrentControlSet\  
Services\Tcpip\Parameters\  
Interfaces\adapter_name
```

Note

If neither of these keys exists, the APIPA mechanism is enabled. If the global key exists but is not enabled, the setting of the global key is decisive. If the global key does not exist or is set to enabled, the card-specific key is decisive.

4. Set the value for `IPAutoconfigurationEnabled` to 1.
The APIPA mechanism is enabled.

6 **ETAS Contact Addresses**

ETAS HQ

ETAS GmbH

Borsigstraße 14

70469 Stuttgart

Germany

Phone: +49 711 3423-0

Fax: +49 711 3423-2106

WWW: www.etas.com

ETAS Subsidiaries and Technical Support

For details of your local sales office as well as your local technical support team and product hotlines, take a look at the ETAS website:

ETAS subsidiaries WWW: www.etas.com/en/contact.php

ETAS technical support WWW: www.etas.com/en/hotlines.php

Index

C

Code
 generating 44, 64
Connection Manager 60

E

ETAS Contact Addresses 87
ETAS EE 12
ETAS Experiment Environment 12
ETAS Network
 Addressing 76
 Configure network adapter 81
 DHCP 76
 Network Manager 77
 Reserved addresses 79

G

GUI
 creating 46

H

Hardware
 configuring 53
Hardware configuration
 creating 53

I

IdleController
 model 38

INCA version

 selecting 31

Inport

 adding 57

Installation 23

 preparation 23

 system requirements 23

 user privileges 24

L

LABCAR Inport 57
LABCAR license models 32
LABCAR Outport 57
LABCAR-CCI 14
LABCAR-LCE 15
LABCAR-LCX 15
LABCAR-MCA 14
LABCAR-MCS 14
LABCAR-NIC 15
LABCAR-NIF 15
LABCAR-NIL 15
LABCAR-OPERATOR
 creating a project 41
 launching 40
LABCAR-OPERATOR version
 selecting 29
LABCAR-RTC V5.1 14
Language versions
 operating system 24

License

- license models 32

M

- Manuals 7

- MATLAB version

 - selecting 30

O

- Operating systems 24

- Operation

 - conventions 6

 - use-case 6

- OS Configurator

 - launching 63

- Oscilloscope

 - creating 46

R

- Real-time operating system

 - configuration 63

S

- Scope of delivery 23

T

- Tutorial 37